



Cold Wire Feeder Manual



Safety Warning	2-3	Parts Lists:	CWH3512 Hand Torch.....	18
Warranty	4		CWM2312 Machine Torch	19
Introduction	4		CWM3512 Machine Torch	19
Description	4-5		CWMT412 Machine Torch	20
TIG Welding Process	5		CWMT512 Machine Torch	20
Specifications	6		CWH Wire Feed Hand Unit	21
Check List	7		CWMES Remote Switch	21
Optional Items	7	Drive Rolls		21
Installation	7-9	Spare Parts		21
Operation	10	CWH1812 Head Accessories		22
Welding	10	CWH2312 Head Accessories		22
Maintenance	10	CWHTL312 Head Accessories		23
Troubleshoot Chart	11	CWH3512		23
Cables and Guides	12	CWM2312 Head Accessories		24
Feeding Difficult Wires / Bracket Extensions	12	CWM3512 Head Accessories		25
Electrical Diagram	13	CWMT412 Head Accessories		26
Functions of Controls	14	CWMT512 Head Accessories		27
Parts Lists:		Tungsten Electrode Information		28
WF5 Feed Unit Left Side	15	Tungsten Preparation		29
WF5 Feed Unit Right Side	16	Welding Parameters		30-31
CWH1812 Hand Torch	17			
CWH2312 Hand Torch	17			
CWHTL312 Hand Torch	18			

NOTE: The important safeguards and instructions appearing in this pamphlet should be read and understood prior to operating your equipment.

September 2015
 CK Worldwide, Inc.
 3501 C St. N.E. Auburn, WA 98002
 tel: (253) 854-5820
 tel: (800) 426-0877
 fax: (253) 939-1746



WARNING:

UNSAFE PROCEDURES OR PRACTICES CAN CAUSE SERIOUS PERSONAL INJURY OR DEATH.

This product, when used for welding or cutting, produces fumes or gases which contain chemicals known to the State of California to cause birth defects and, in some cases, cancer.

California Health & Safe Code 25249.5 et seq.

All end users of this equipment, the operators and helpers, must read and understand these safety instructions.



PREVENT ELECTRICAL SHOCK:

Touching live electrical parts can cause severe burns or fatal shock.

1. Do not touch live electrical parts.
2. Do not work in wet or damp areas.
3. Wear dry insulating gloves and body protection.
4. Disconnect all power before installing or servicing this equipment.
5. Turn off all equipment when not in use.
6. Properly install and ground the welding power source according to its Owner's Manual and all applicable codes.
7. Do not use worn or damaged cables or cables that are too small or poorly spliced.
8. Do not wrap cables around your body.
9. Do not touch electrode and any grounded object or circuit at the same time.
10. Use only well-maintained equipment. Repair or replace damaged parts at once.



PROVIDE PROTECTION FROM FUMES AND GASES:

Breathing welding fumes and gases can be hazardous to your health.

1. Keep your head out of welding fumes.
2. Use adequate ventilation in the work area to keep fumes and gases from your breathing zone and the general work area.
3. If ventilation is inadequate, use an approved breathing device.
4. Read and understand the Material Safety Data Sheets (MSDS) and the manufacturer's instructions for any materials used.



PROTECT COMPRESSED GAS CYLINDERS:

Gas cylinders are normally used when welding, treat them with care.

1. Protect compressed gas cylinders from excessive heat, mechanical shocks and arcs.
2. Install and secure cylinders so that they cannot fall or tip over by fastening them to a mounting bracket, wall or other stationary support.
3. Keep cylinders away from any welding or other electrical circuits.
4. Never allow a welding electrode to touch any cylinder.

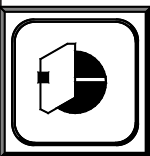

PROTECT EYES AND SKIN FROM ARC RAYS, PROTECT EARS FROM NOISE:

Welding arc rays produce intense heat and ultraviolet rays that can burn eyes and skin. Noise from some processes can also damage hearing.

1. Wear a welding helmet fitted with a proper filter lens (see ANSI Z49.1 for detailed information).
2. Use protective screens or barriers to protect others from welding flash and glare.
3. Wear protective clothing and foot protection.

NOTE:

The important safeguards and instructions appearing on this pamphlet should be read and understood prior to operating your equipment.



PREVENT FIRES AND BURNS:

The hot workpiece, hot equipment, spatter, and arc sparks can cause fires and burns.

1. Wear correct eye, face, and body protection in the work area.
2. Allow work and equipment to cool before handling.
3. Do not weld near flammable materials.
4. Watch for fire, and keep a fire extinguisher nearby.
5. For additional information, refer to NFPA Standard 51B, "Fire Prevention in Use of Cutting and Welding Processes", available from the National Fire Protection Association, Batterymarch Park, Quincy MA 02269.



PROVIDE PROTECTION FOR SPECIAL SITUATIONS:

1. Do not weld or cut containers or materials which have held or been in contact with hazardous substances unless they are properly cleaned and inspected.
2. Do not weld or cut painted or plated parts unless special ventilation is provided to remove highly toxic fumes or gases.
3. Since welding can affect pacemakers, keep all pacemaker wearers out of the work area. Have them consult a doctor before coming near a welding operation.



PROVIDE PROPER EQUIPMENT MAINTENANCE:

Improperly maintained equipment can result in poor work, but most importantly it can cause physical injury or death through fires or electrical shock.

1. Always have qualified personnel perform the installation, troubleshooting, and maintenance work. Do not perform any electrical work unless you are fully qualified.
2. Before performing any maintenance work inside a power supply, disconnect the power supply from the electrical power source.
3. Maintain cables, grounding wire, connections, power cord, and power supply in a safe working order. Do not operate any equipment in questionable condition.
4. Do not abuse any equipment or accessories. Keep equipment away from heat sources such as furnaces, wet conditions such as water puddles, oil or grease, corrosive atmospheres, and inclement weather.
5. Keep all safety devices, guards, panels, and covers in position and in good repair.
6. Use equipment for its intended purpose. Do not modify it in any manner.

ADDITIONAL SAFETY INFORMATION:

For more information on safe practices for setting up and operating electric welding and cutting equipment and on good working habits, ask your welding equipment supplier. For your protection, read and comply with the latest editions of the following standards:

- | | |
|--|---|
| 1. ANSI Standard Z49.1
Available from the American Welding Society, 550 N.W. LeJeune Rd., Miami FL 33126. | 5. CSA Standard W117.2
"Code for Safety in Welding and Cutting", available from the Canadian Standards Association, 178 Rexdale Blvd., Rexdale, Ontario, Canada M9W 1R3. |
| 2. ANSI Standard Z87.1
"Safe Practices for Occupation and Educational Eye and Face Protection", available from the American National Standards Institute, 1430 Broadway, New York, NY 10018. | 6. NFPA Standard 51B
"Fire Prevention in Use of Cutting and Welding Processes", available from the National Fire Protection Association, Batterymarch Park, Quincy MA 02269. |
| 3. AWS Standard A6.1
"Recommended Safe Practices for Shielded Arc Welding", available from the American Welding Society 550 N.W. LeJeune Rd., Miami FL 33126. | 7. NFPA Standard 70
"National Electrical Code", available from the National Fire Protection Association, Batterymarch Park, Quincy MA 02269. |
| 4. AWS Standard F4.1
"Recommended Safe Practices for the Preparation for Welding and Cutting of Containers and Piping that have Held Hazardous Substances", available from the American Welding Society 550 N.W. LeJeune Rd., Miami FL 33126. | 8. OSHA Standard 29 CFR, Part 1910, Subpart Q
"Welding, Cutting, and Brazing", available from the Superintendent of Documents, U.S. Government Printing Office, Washington D.C. 20402. |



WARRANTY:

CK Worldwide, Inc. warrants the cold wire feed unit (WF-5) against defects in materials and workmanship for a period of one year from the date of purchase. Should it become defective for such reason, the Manufacturer will repair it without charge, if it is returned to the Manufacturer's factory, freight prepaid. Prior to returning the equipment, written authorization, in the form of an RGA number must be obtained prior to any returns for any reason. This warranty does not cover: (1) failure due to normal wear and tear; (2) consumable parts, such as, but not limited to, feed cables, wire guides, torch and torch parts; (3) damage by accident, force majeure, improper use, neglect, unauthorized repair or alteration; (4) any one other than the original purchaser. In any event, CK Worldwide, Inc. will only be responsible for its products when used with accessory items manufactured by CK Worldwide, Inc.

This limited warranty is in lieu of all other warranties, express or implied. The manufacturer shall not be liable for any injury to persons, including death; or loss or damage to any property, direct or consequential, including, but not limited to loss of use, arising out of the use, or the inability to use, the product. The user assumes all risk and liability whatsoever in connection with the use of the product, and before doing so shall determine its suitability for his intended use, and shall ascertain the proper method of using it. This warranty gives you specific legal rights, and you may have other rights, which may vary from state to state.

INTRODUCTION:

The patented CK Cold Wire TIG System is used in the Gas Tungsten Arc Welding (GTAW) / Tungsten Inert Gas (TIG) process to provide automatic or semiautomatic feeding of the filler metal. Depending on the configuration of the system, it can be used to feed .025" (.65mm) through 1/16" (1.6mm) diameter stainless steel / alloy steel wire or .035" (.9mm) through 1/16" (1.6mm) aluminum wire from standard 12" (30.5mm) spools.

DESCRIPTION:

The CK Cold Wire TIG System consists of (1) The Cold Wire TIG Wire Feed Unit and (2) The Cold Wire TIG Torch Outfit. The Wire Feed Unit is a model WF-5. The TIG Torch Outfit includes the feed cable and wire guide. The application and features of each is described below. See pages 17 through 21 for the model numbers of standard CK Cold Wire TIG Torch Outfits

WF5:

The WF5 Wire Feed Unit can be used with hand held CK torches for semiautomatic operation or with machine mounted CK torches for fully automatic operation. The WF5 Feed Unit houses the drive motor, feed roll mechanism, solid state control circuitry, and spool of filler wire. It has a ten turn potentiometer for wire feed speed adjustment and a toggle switch for continuous or pulsed wire feed operation. For automatic operation, it has controls for delay start and wire retract capabilities. The WF5 is supplied with one dual grooved drive roll for two sizes of wires and one pressure roll of the size and type best suited for the filler wire being used (as specified at time of order). See page 21 for a range of available drive rolls.

DESCRIPTION:

TORCH OUTFIT:

The CK Cold Wire TIG Torch Outfit is a hand held or machine mounted CK TIG torch with the built in added capacity of delivering a filler wire directly to the weld puddle. The torch outfit includes torch, power cable, feed cable, wire guide and wire guide bracket. The feed cable is fitted with a replaceable, low-friction cable liner. Various torch configurations are available. All models use standard CK collets, collet bodies and gas cups. See pages 22 through 27 for parts and order numbers.

TIG WELDING PROCESS:

The TIG welding process uses a nonconsumable tungsten electrode secured in the TIG torch. The welding arc is produced between the tungsten electrode and the work. The weld is shielded by a stream of Argon gas, Helium gas, or a mixture of the two, which is fed through the torch, around the electrode and to the molten weld puddle. Filler metal is added to the weld puddle as required. The Cold Wire TIG System mechanizes the addition of the filler metal to ensure consistent, high quality welds. The TIG welding process is the first choice for welding thin sections, welding thin-wall tubing, making pipe joint root passes, and other similar critical welding applications.

NOTE: Cold Wire TIG welding of tubing under 2-1/2" (6.4cm) diameter requires CWH pendant style feed unit and separate TIG torch. Unless being used with turn table or pipe roller.

The TIG welding process requires a constant current welding power source. Power sources designed specifically for TIG welding may include a built in high frequency arc stabilizer, shielding gas control solenoid, cooling water control solenoid and other special equipment. They may be AC or DC or a combination of AC/DC units. The proper current for TIG welding depends on the material being welded, speed of application and on the desired weld characteristics.

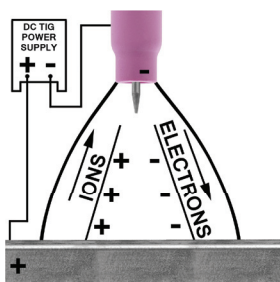

DIRECT CURRENT STRAIGHT POLARITY (DCSP):

DC straight polarity produces the deepest penetration because the heat of the weld is concentrated at the work or joint. Straight polarity provides no cleaning action (removal of surface oxides). This polarity is generally used to weld most materials except aluminum and magnesium. May be used with or without high frequency starting.

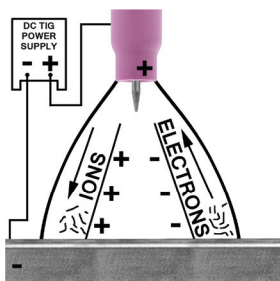

DIRECT CURRENT REVERSE POLARITY (DCRP):

DC reverse polarity provides good cleaning action. The combining force of the shielding gas ions striking the work surface and the flow of electrons from the work, cause the surface oxides to be broken away. Penetration is shallow because the heat of the weld is concentrated at the electrode. The use of DCRP is limited to special applications. Maybe used with or without high frequency starting.

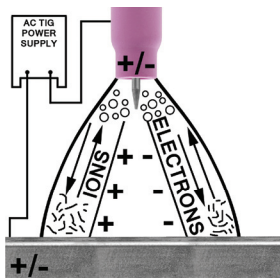

ALTERNATING CURRENT HIGH FREQUENCY (ACHF):

AC combines the good penetration of straight polarity (electrode negative half cycle) and the good cleaning action of reverse polarity (electrode positive half cycle). Continuous high frequency is necessary to reestablish the arc which breaks between each half cycle. ACHF current is generally used to weld aluminum and magnesium.



SPECIFICATIONS:

WF5 WIRE FEED UNIT:

Voltage:	115V AC (220V AC 50hz - special item)
Phase:	Single Phase
Frequency:	50 / 60 hz.
Height:	15 in. (38.1cm)
Width:	10 in. (25.4cm)
Length:	21 in. (53.3cm)
Weight:	54 lbs. (24.5 kg.)
Filler Wire Spool Size:	12 in. (30.5cm)
Filler Wire Sizes:	.023" (.58mm), .030" (.76mm), .035" (.9mm), .045" (1.1mm), 1/16" (1.6mm)
Wire Feed Speed Range:	0-700 in/min (0-1,775cm/min)
Feed Time (pulsed mode):	continuously variable
Dwell Time (pulsed mode):	continuously variable
Delay Start Time (continuous mode):	continuously variable
Wire Retract Time (continuous mode):	continuously variable

HAND TORCHES:

CWH1812 Rating at 100% Duty Cycle:	180 amp ACHF or DCSP
CWH2312 Rating at 100% Duty Cycle:	300 amp ACHF or DCSP
CWHTL312 Rating at 100% Duty Cycle:	350 amp ACHF or DCSP
CWH3512 Rating at 100% Duty Cycle:	400 amp ACHF or DCSP
Cooling Method:	Water
Torch Cable Length:	12-1/2 ft (3.81m)
Feed Cable Length (soft wire):	8 ft. (2.44m)
Feed Cable Length (hard wire):	10 ft. (3.05m)

MACHINE TORCHES*:

CWM2312 Rating at 100% Duty Cycle:	300 amp ACHF or DCSP
CWM3512 Rating at 100% Duty Cycle:	400 amp ACHF or DCSP
CWMT412 Rating at 100% Duty Cycle:	400 amp ACHF or DCSP
CWMT512 Rating at 100% Duty Cycle:	500 amp ACHF or DCSP
Cooling Method:	Water
Torch Cable Length:	12-1/2 ft (3.81m)
Feed Cable Length (soft wire):	8 ft. (2.4m)
Feed Cable Length (hard wire):	10 ft. (3m)

***REMOTE SWITCH REQUIRED:**

PART NUMBER: CWMES
See Page 21



CHECKLIST:

- WF5 Wire Feed Unit
- Drive Roll Set - for wire size and type specified (installed)
- Torch Outfit with Feed Cable, Wire Guide and Wire Guide Bracket - model specified at time of order

OPTIONAL ITEMS:

CWMES:

Remote switch with 11 ft. (3.4m) lead - required for machine torch operation, but must be ordered as a separate item.

CWH:

Hand held feed assembly and remote switch with 8 ft. (2.4m) feed cable for soft wire, 10 ft. (3m) feed cable for hard wire.

ITEMS REQUIRED FOR COLD WIRE TIG WELDING NOT PROVIDED:

1. Welding power source - suitable for TIG welding.
2. Water recirculator - for cooling welding torch.
3. Regulator / Flowmeter - for control of shielding gas flows.
4. Shielding gas and cylinders.
5. Full cover welding helmet with proper shaded lens.
6. Leather welding gloves.
7. 12" (30.5cm) spool of welding wire.
8. Ground Cable - sized to suit current range - and ground clamp.

INSTALLATION:

The CK Cold Wire TIG Wire Feed Unit requires 115 volts Alternating Current to operate. The 115V MUST be supplied by an ISOLATED, GROUNDED outlet. Do not connect to the 115V AC outlet on the power source. 220V also available.

1. Attach the water cooled power cable of the TIG torch to the electrode terminal on the power source. A power cable adapter is required to make the proper connection (the water cooled power cable is the water out line).
2. Attach the ground cable from the power source ground terminal to the work or fixture. The ground cable should be adequate size and no longer than the torch leads.
3. Attach the torch water in and gas supply hoses to their respective connections points.
4. Plug the feed unit control cord into an isolated, grounded 115V AC outlet. Do not connect feed unit control cord into the 115V AC on the welding power source. For feed units requiring 220V AC, install an appropriate plug. Then plug the feed unit control cord into an isolated, grounded 220V AC outlet.
5. Do not set the Cold Wire Feeder directly on the power supply without an insulating barrier.

INSTALLATION:

FITTING AND THREADING THE FILLER WIRE:

- Remove the right side Wire Feed Unit cover and install a spool of welding wire. Drive rolls have two grooves. Check the feed roll to be sure it is on the correct side for the filler wire being used. See page 21 for drive roll sizes. Unlatch and raise the pressure roll arm. Thread the wire through the inlet guide to the drive rolls. Feed the wire across the drive roll groove and into the feed cable inlet guide. Close and relatch the pressure roll arm.

CAUTION: Do not feed wire through the drive rolls under pressure.

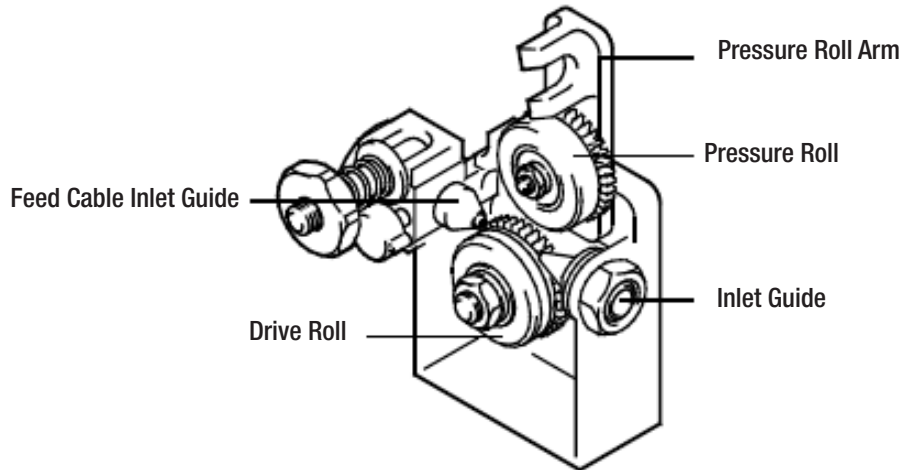

- After the wire has been started into the feed cable, straighten feed cable and feed wire under power by actuating the torch switch. Keep the Feed Cable as straight as possible and continue pushing the switch until the wire has completely fed through.

CAUTION: Keep hands away from the wire guide end while feeding the wire through the feed cable.

NOTE: When using soft aluminum wire, it may be necessary to unscrew the compression nut fastening the feed tube to the wire guide, and manually feed the wire through the wire guide.

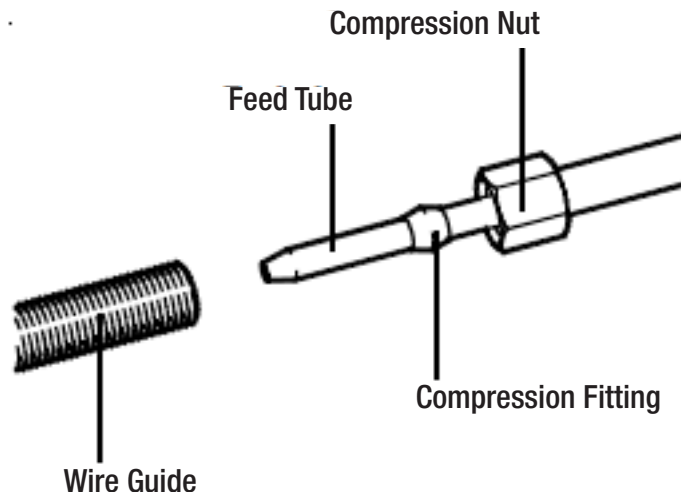



INSTALLATION:

WIRE FEED ROLL ADJUSTMENT:

8. The wire feed rolls and spool brake are properly adjusted at the factory, prior to delivery. As components "seat in", it may be necessary to adjust the settings.

IMPORTANT: To adjust the feed rolls, tighten the pressure roll adjusting nut approximately one-half turn past the point where the rolls just begin to "grab" the welding wire.

WARNING: Feed rolls that are adjusted too tightly will result in deformed wire and needless overload of the drive motor.

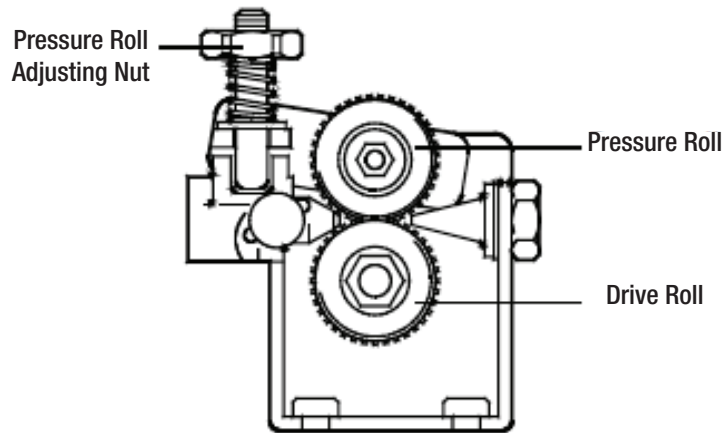

SPOOL BRAKE ADJUSTMENT:

9. Adjust the spool brake by turning the brake adjusting nut IN to increase braking force and OUT to decrease the braking force. Adjust the brake just tight enough to prevent the welding wire from over-running when feeding has stopped.

WARNING: Too much braking force will needlessly overload the drive motor.

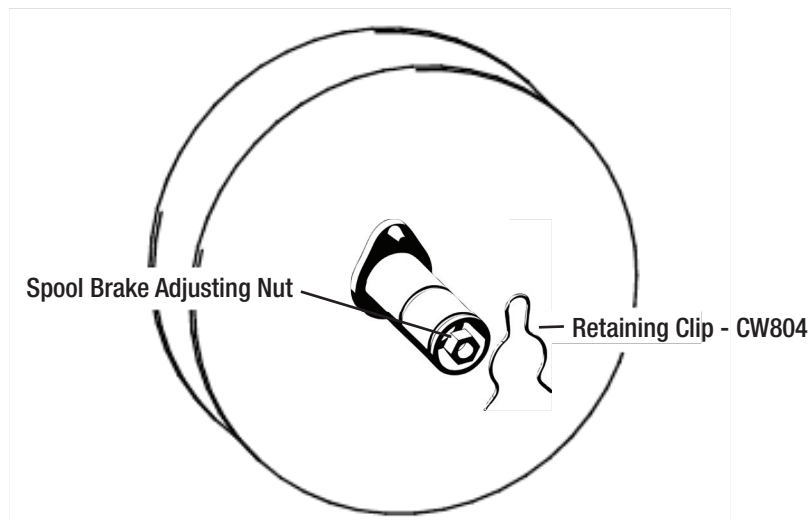

NOTE: Always replace and lock the cover door after loading wire.



OPERATION:

Prior to commencing welding, the following preparations should be made to ensure optimum performance of the system.

1. Make sure that the pieces of metal to be welded are free of grease, dirt, paint, and scale. Use a wire brush to remove dirt and scale. Use a stainless steel wire brush on stainless or aluminum. Paint must be completely removed to bare metal. Failure to clean the metal properly will result in porous and contaminated welds.
2. Check that the system has been properly installed per the installation instructions.
3. Check the control cable and weld cables for proper connection. Make sure the ground clamp is firmly attached to a cleaned area on the piece to be welded.
4. Prepare the torch for welding. Check the gas supply and adjust the flowmeter for the recommended flow rate. Check the water circulator for proper operation.
5. Set the controls on the power source and the Cold Wire TIG Feed Unit.

WELDING:

With the shield gas flowing, initiate an arc between the tungsten electrode and the workpiece. When the desired weld pool has formed, depress the switch on the torch to start the wire feeding. Adjust the Wire Speed and, if in Pulse mode adjust the Drive time and Dwell time to produce the desired bead.

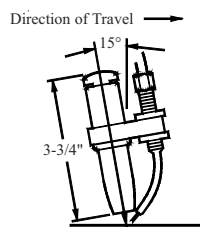

HAND HELD:

The recommended torch angle for hand held welding is 15° from perpendicular. The filler wire is fed into the leading edge of the molten pool.

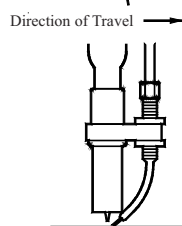

MACHINE:

The recommended torch angle for machine mounting welding is perpendicular. The filler wire is fed into the leading edge of the molten pool.

MAINTENANCE:

1. Blow foreign matter from the feed cable with compressed air before loading a new spool of welding wire.
2. Replace the wire guide tube if it has been arced, bent, or is badly worn.
3. Wire drive motor brushes should be inspected at regular intervals and replaced if worked to a 1/4" (6.4mm) length.

NOTE:

Whenever a brush is removed for inspection, be sure it is put back in the same position. It must not be turned around in the brush holder. Excessive arcing and loss of power will result if it is put back incorrectly.



TROUBLESHOOTING CHART:

This troubleshooting chart is a guide in identifying and correcting possible troubles which may occur when operating this equipment.

PROBLEM	CAUSE	SOLUTION
Pilot light is out	<ol style="list-style-type: none"> Unit is not plugged in. Switch is in off position. Switch is faulty. Light is burned out. Circuit breaker is blown. 	<ol style="list-style-type: none"> Plug in unit. Turn switch to on position. Replace switch. Replace light. Reset or replace circuit breaker.
Drive indicator light does not light when remote switch is engaged	<ol style="list-style-type: none"> Light is burned out. Remote switch is faulty. Switch wire is damaged. Amphenol plug is damaged. Motor control board is faulty. Power to unit is off. 	<ol style="list-style-type: none"> Replace light. Replace remote switch. Repair or replace switch wire. Repair or replace Amphenol plug. Replace motor control board. Turn power on.
Loss of wire feed	<ol style="list-style-type: none"> Circuit breaker tripped. Motor control board is faulty. Potentiometer is set at zero. Wire supply is exhausted. Wire feed cable tangled. Wire is bird nested. Feeder is unplugged. Feed cable is plugged. Drive roll is misaligned. Drag is excessive. Wire guide tube has worn out. 	<ol style="list-style-type: none"> Reset circuit breaker. Replace motor control board. Set wire feed speed. Resupply wire. Straighten feed cable. Loosen pressure roll / re-thread wire. Plug in feeder to a 115V AC wall outlet. Replace feed cable. Align inlet and outlet guides with drive roll. Adjust spool brake. Replace wire guide tube.
Erratic wire feeding	<ol style="list-style-type: none"> Feed unit plug is connected to power supply. Wire tangled on spool. Wrong or worn feed cable. Wrong or worn wire guide. Wrong drive roll groove. Incorrect drive roll pressure. 12V DC relay failed. 	<ol style="list-style-type: none"> Unplug then plug into 115V AC wall outlet. Remove tangled section and rethread. Replace feed cable. Replace wire guide. Refer to chart on Page 21. Adjust pressure roll. Replace relay.
Faulty Delay - Retract	<ol style="list-style-type: none"> Potentiometer failed. Toggle switch failed. 12V DC relay failed. 	<ol style="list-style-type: none"> Replace potentiometer. Replace toggle switch. Replace relay.
Motor will not turn off	<ol style="list-style-type: none"> Faulty trigger switch. Switch control cable damaged. Amphenol plug shorted. 12V DC relay failed. Logic board failed. 	<ol style="list-style-type: none"> Repair or replace switch. Repair or replace cable. Repair or replace plug. Replace relay. Replace logic board.
Wire will not feed	<ol style="list-style-type: none"> Coiled feed cable - friction on wire. Wire is bent or curved. 	<ol style="list-style-type: none"> Keep feed cable as straight as possible. Keep wire straight as it enters feed rolls.

Not affiliated with this equipment, refer to power source owners manual.

Loss of weld current	<ol style="list-style-type: none"> Weld cables disconnected. Power source contactor open. Poor contactor connection. 	<ol style="list-style-type: none"> Repair or replace cables. Check contactor connections. Make proper connections.
Erratic weld current	<ol style="list-style-type: none"> Poor ground connection. Poor welding cable connection. 	<ol style="list-style-type: none"> Make proper connections. Make proper connections.



CABLES AND GUIDES:

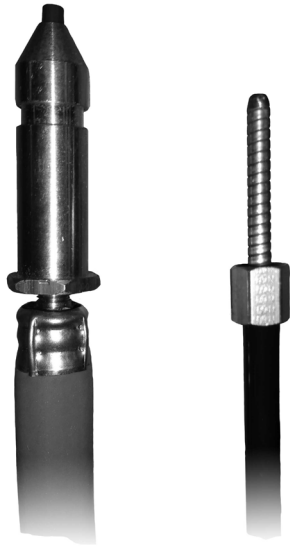

WIRE TYPE	WIRE SIZE:	FEED CABLE:
Hard Wire: -10 ft. (3m) for Stainless Steel -Black Strain Relief	.023" (.55mm)	CW-FC
	.030" (.8mm)	CW-FC
	.035" (.9mm)	CW-FC
	.045" (1.1mm)	CW-FC
	1/16" (1.6mm)	CW-FC116
Soft Wire: -8 ft. (2.4m) for Aluminum -Red Strain Relief	.023" (.55mm)	Not recommended
	.030" (.8mm)	Not recommended
	.035" (.9mm)	CW-FCN
	.045" (1.1mm)	CW-FCN116
	1/16" (1.6mm)	CW-FCN116

TORCHES:	WIRE SIZE:	REPLACEMENT TIP:	REPLACEMENT TUBE:	WIRE GUIDE ASSEMBLIES:
Body Mount: (CWH180) (CWH230) (CWM230) (CWMT500)	.023" (.55mm)	CWT023	CWGB (Curved)	CWG023B(S)
	.030" (.8mm)	CWT030		CWG030B(S)
	.035" (.9mm)	CWT035		CWG035B(S)
	.045" (1.1mm)	CWT045	CWGBS (Straight)(S)	CWG045B(S)
	1/16" (1.6mm)	N/A		CWG116B(S)
Head Mount: (CWH), (CWM), (CWH150), (CWH210), (CWHTL312), (CWH350), (CWM350), (CWMT400)	.023" (.55mm)	CWT023	CWGH (Curved)	CWG023H(S)
	.030" (.8mm)	CWT030		CWG030H(S)
	.035" (.9mm)	CWT035		CWG035H(S)
	.045" (1.1mm)	CWT045	CWGHS (Straight)(S)	CWG045H(S)
	1/16" (1.6mm)	N/A		CWG116H(S)

NOTE: A bracket extension is needed for complete installation with a part number of 3-WGBX-60.

FEEDING DIFFICULT WIRE/BACKET EXTENSION:

Due to the nature of certain wires it may be difficult to feed a wire through the length of the feed cable and through the curved wire guide. Friction and drag may put too much resistance on the wire when it is forced through the curved wire guide. Typically this is encountered when using very small diameter soft wires and large diameter hard wires. To alleviate this problem a wire guide extension bracket is recommended. This will relieve the resistance on the wire. In addition to the use of the wire guide extension bracket, it is important to keep the feed cable as straight as possible.

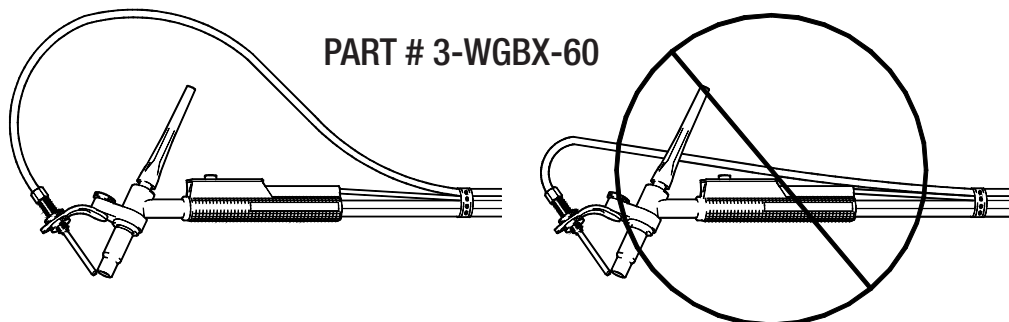

WF5 ELECTRICAL DIAGRAM:

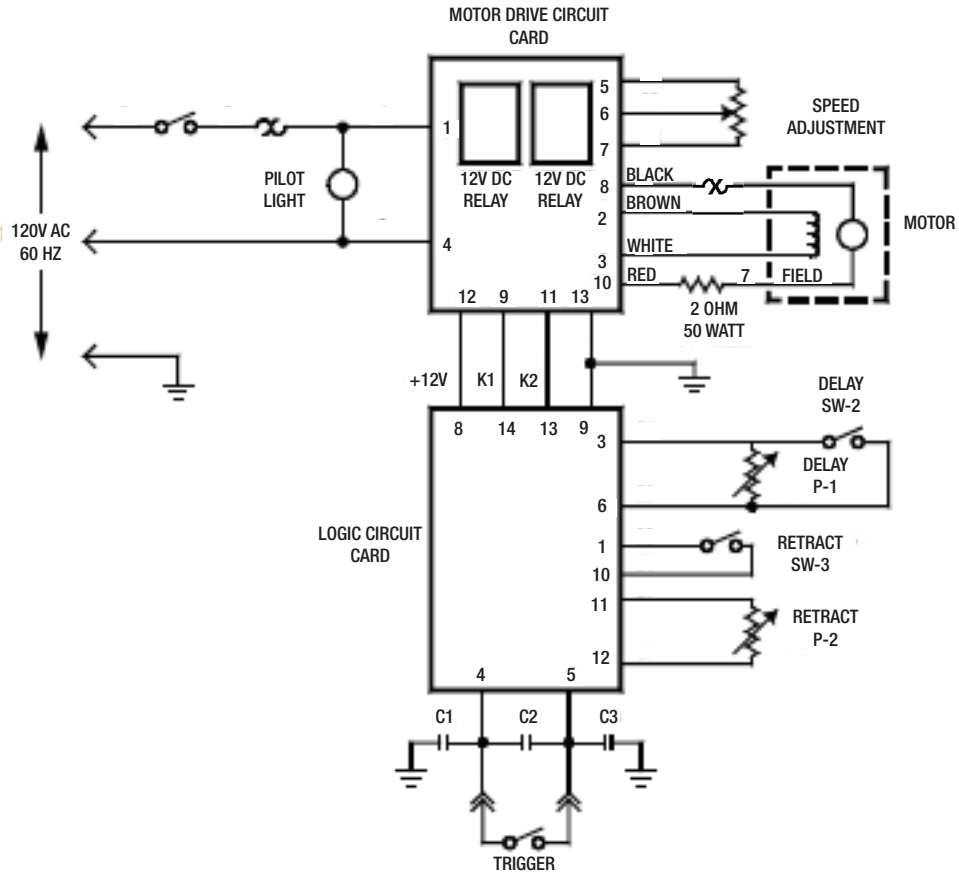



FUNCTIONS OF CONTROLS:

The following controls are located on the front of the WF5 wire feed unit.



FUNCTIONS OF CONTROLS:

- | | |
|--|---|
| <p>A. ON / OFF Switch
Main power switch - energizes control circuit and pilot light.</p> <p>B. Delay Start Time Control
Variable resistor - sets the time delay from remote switch actuation to wire feed start.</p> <p>C. Delay Start ON / OFF Switch
Activates the delay start timer.</p> <p>D. Drive Time Control
Variable resistor - sets the on time of the wire feeding into the weld puddle in pulse mode.</p> <p>E. Pulse / Continuous Selector Switch
Controls mode of operation - Continuous or Pulse wire feed mode.</p> <p>F. Circuit Breaker
5 amp breaker provides overload protection for control circuit.</p> <p>G. Remote Amphenol
WF5 activation.</p> | <p>H. Wire Speed Control
Ten turn potentiometer - controls speed of wire drive motor.</p> <p>I. Pilot Light
Illuminates when feed unit is on.</p> <p>J. Retract Time Control
Variable resistor - controls time of wire in retract mode.</p> <p>K. Retract ON / OFF Switch
Activates wire retract circuit.</p> <p>L. Dwell Time Control
Variable resistor - sets the off time of the wire when not feeding wire into weld puddle in pulse mode.</p> <p>M. Drive Indicator Light
Illuminates when motor is feeding wire.</p> <p>N. Feed Cable Connection
Connection point for wire feed cable.</p> |
|--|---|



PARTS: WF5 COLD WIRE FEED UNIT LEFT SIDE VIEW: (see page 18 for right side view)

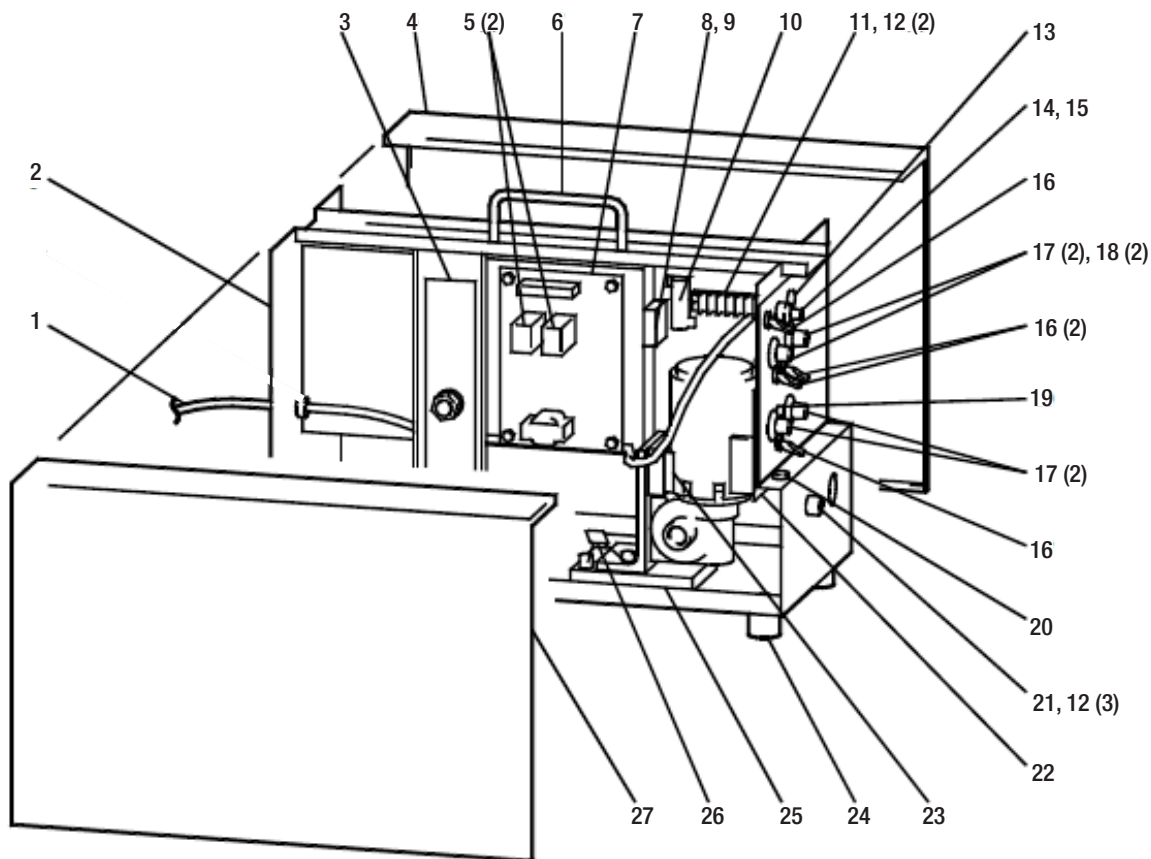

PARTS LIST: ITEM: PART NUMBER: DESCRIPTION:

1	312003-01	Power Cord
2	400-0001-81	Cabinet
3	400-0037-81	Strap, Spool Hub
4	400-0004-81	Right Door
5	400-0168-87 (2)	12V DC Relay
6	DK-1107	Handle
7	400-0170-87	Motor Drive Circuit Card
8	400-2026-95	Fuse Holder
9	400-2027-95	Fuse 5 amp, 250 Volt
10	01-2207-79	2 Ohm Resistor
11	400-0176-79	Terminal Board
12	400-0018-81 (5)	Capacitor 3 on Amphenol Connector 2 on Terminal Board

ITEM: PART NUMBER: DESCRIPTION:

13	01-5089-79	Pilot Light
14	400-0130-82	10 Turn Dial
15	400-0129-82	10 Turn Potentiometer
16	400-0012-81 (4)	2 Position Switch
17	400-0009-81 (4)	Knob
18	400-0177-87 (2)	100 K Potentiometer
19	400-0111-81	Pilot Light
20	400-0015-81	Circuit Breaker, 5 amp
21	11-0051-79	Amphenol Receptacle
22	400-0169-87	Logic Circuit Card
23	400-0167-87	Motor Spacer
24	001-1107-79 (4)	Footpad
25	400-0166-87	Motor Pad
26	400-0181-92	Capacitor
27	400-0003-81	Left Door



PARTS: WF5 COLD WIRE FEED UNIT RIGHT SIDE VIEW:

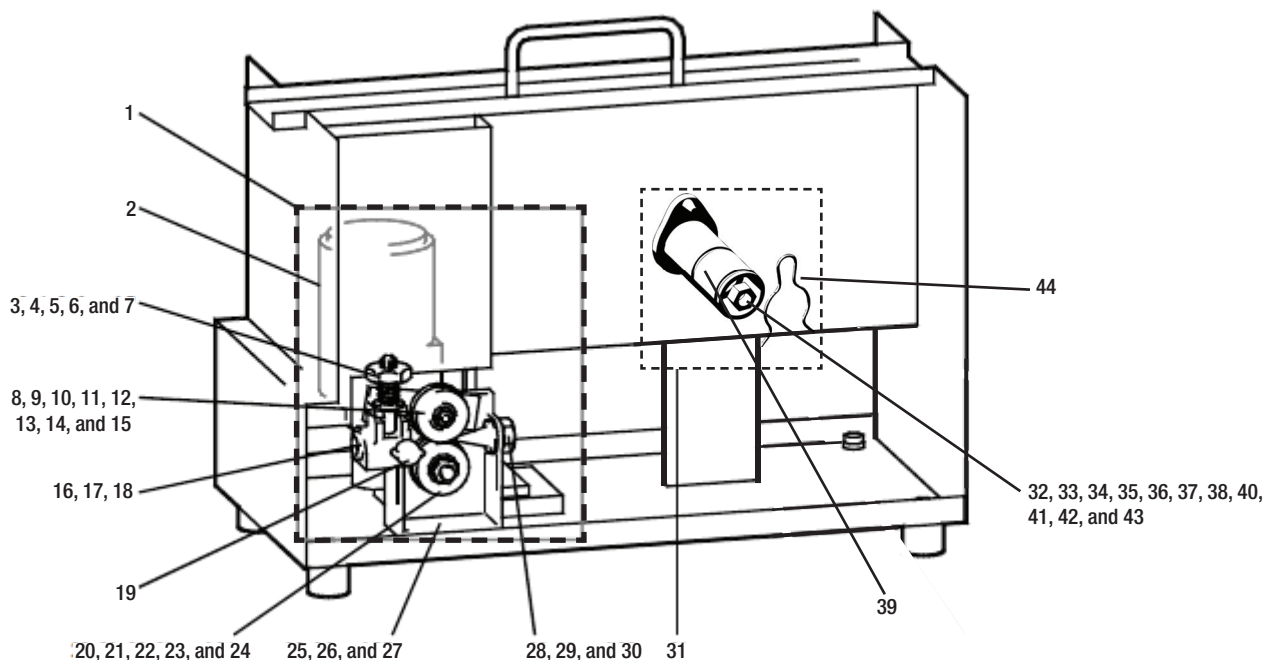

PARTS LIST: ITEM: PART NUMBER: DESCRIPTION:

1 CW900 Motor and Drive Assembly

Consisting of the following:

2	CW400	Motor and Gear Box
3	CW111	Pressure Roll Tension Bolt
4	CW109	Tension Nut
5	CW110	Pressure Spring
6	CW112 (2)	Tension Bolt Washer
7	CW113	Tension Bolt Roll Pin
8	CW101	Pressure Roll
9	CW104	Pressure Roll Screw
10	CW103	Pressure Roll Bushing
11	CW105	Pressure Roll Retainer Nut
12	CW108	Pressure Roll Spacer
13	CW100	Pressure Roll Arm
14	CW106	Shoulder Bolt
15	CW107	Spring Washer
16	CW303	Outlet Guide Mount
17	CW304	Outlet Guide Washer
18	CW305	Outlet Guide Nut
19	CW306	Thumb Screw
20	Drive Roll - Select from:	
	30-45DR	.030" - .045" (.8mm - 1.1mm) Wire
	45-564DR	.045" - 1/16" (1.1mm - 1.6mm) Wire

ITEM: PART NUMBER: DESCRIPTION:

21	CW201	Drive Shaft Key
22	CW203	Drive Roll Lockwasher
23	CW204	Drive Roll Nut
24	CW200	Drive Roll Gear
25	CW500	Drive Housing Bracket
26	CW503 (3)	Drive Housing Bolt
27	CW504 (3)	Drive Housing Lockwasher
28	CW300	Inlet Guide
29	CW302	Inlet Guide Washer
30	CW301	Inlet Guide Nut

31 CW800 Hub Assembly

Consisting of the following:

32	CW810	Bolt
33	CW805	Flat Washer
34	CW802	Tension Spring
35	CW806	Notched Washer
36	CW811	Bushing
37	CW803	Shaft
38	CW811	Bushing
39	CW801	Spool Holder
40	CW807	Nylon Flat Washer
41	CW805	Flat Washer
42	CW808	Lock Washer
43	CW809	Bolt
44	CW804	Wire Spool Retaining Clip



PARTSLIST:

CWH1812 HAND TORCH:

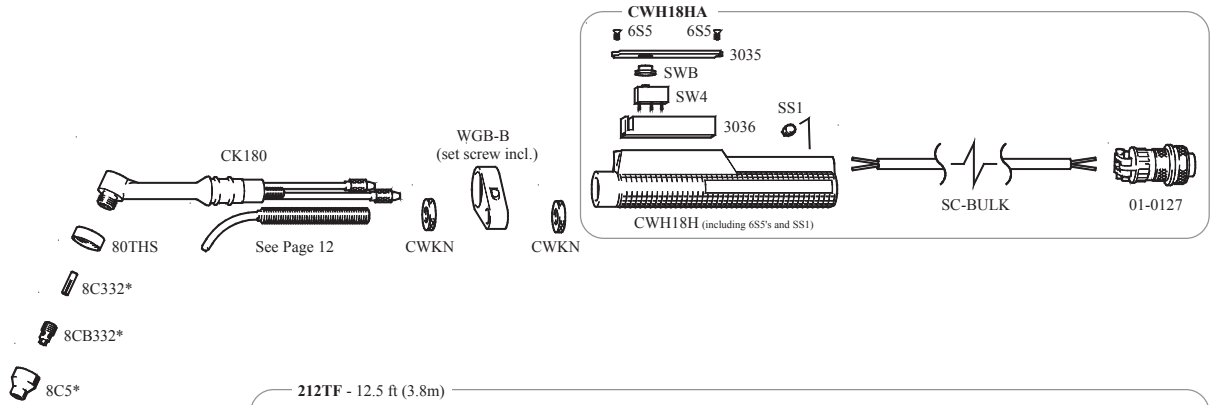

* Note: See Page 22 for additional options on head consumables.

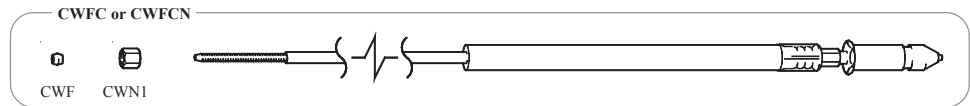
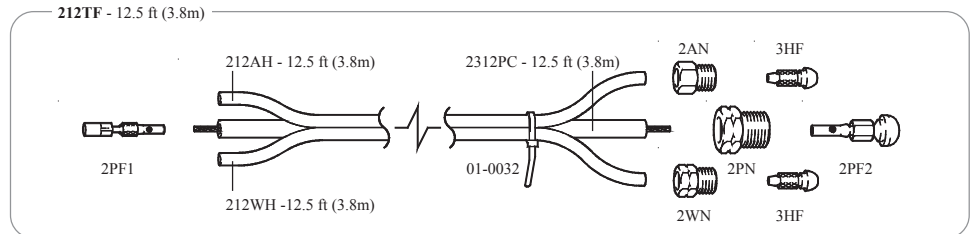

PARTSLIST:

CWH2312 HAND TORCH:

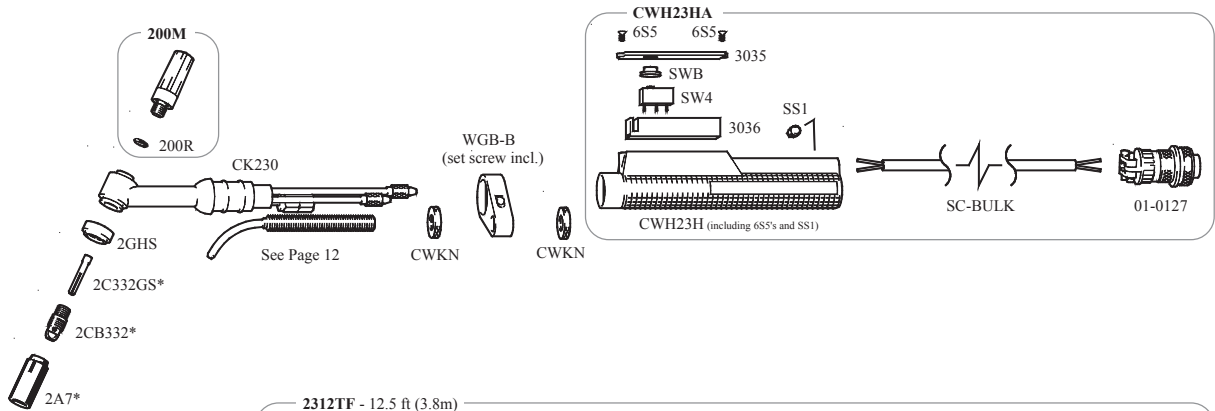

* Note: See Page 22 for additional options on head consumables.

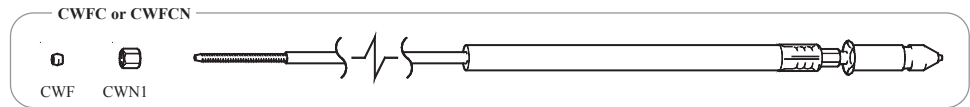
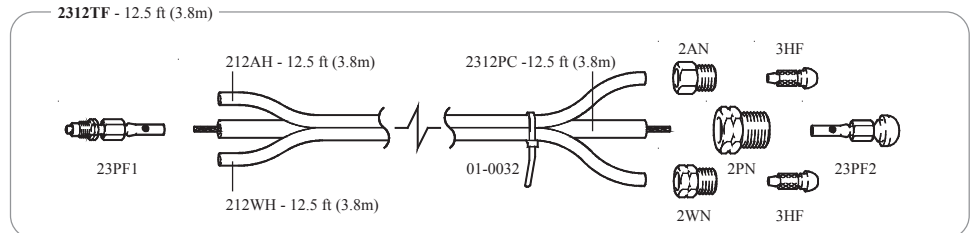

PARTSLIST: CWHTL312 HAND TORCH:

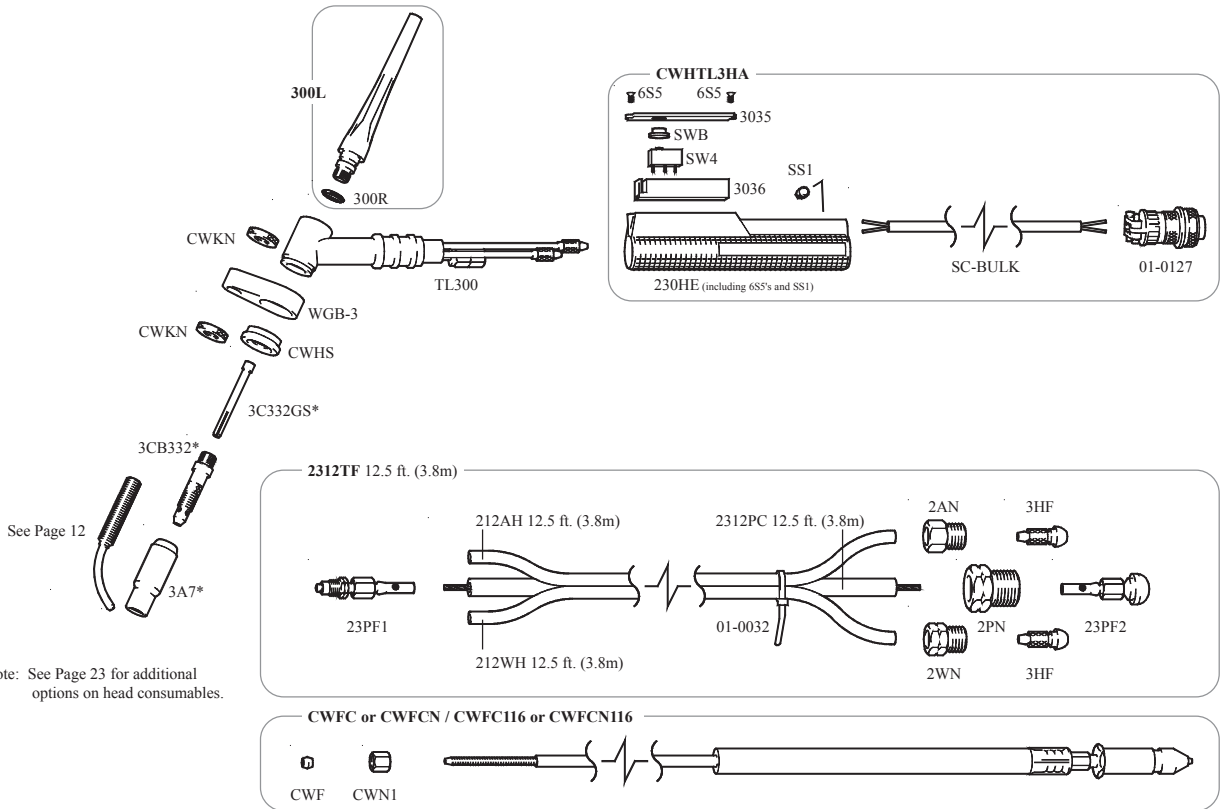

PARTSLIST: CWH3512 HAND TORCH:

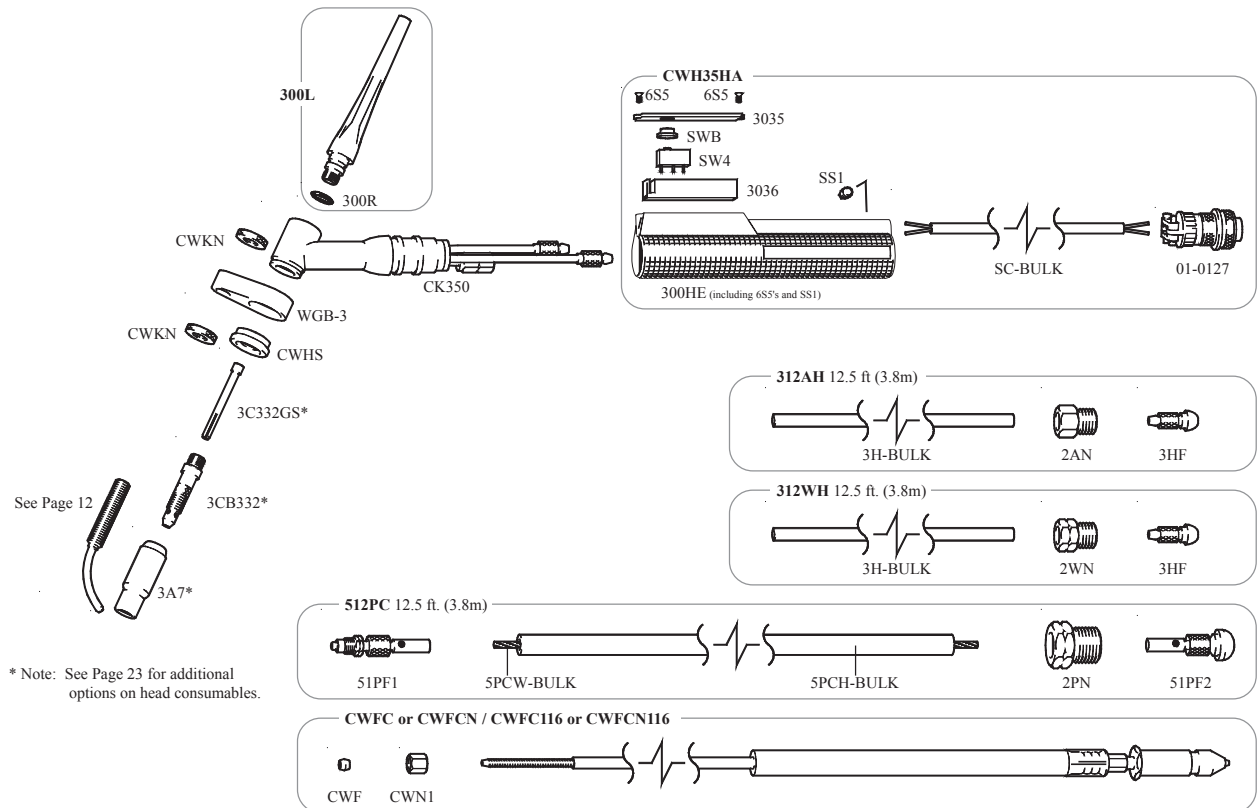



PARTSLIST:

CWM2312 MACHINE TORCH:

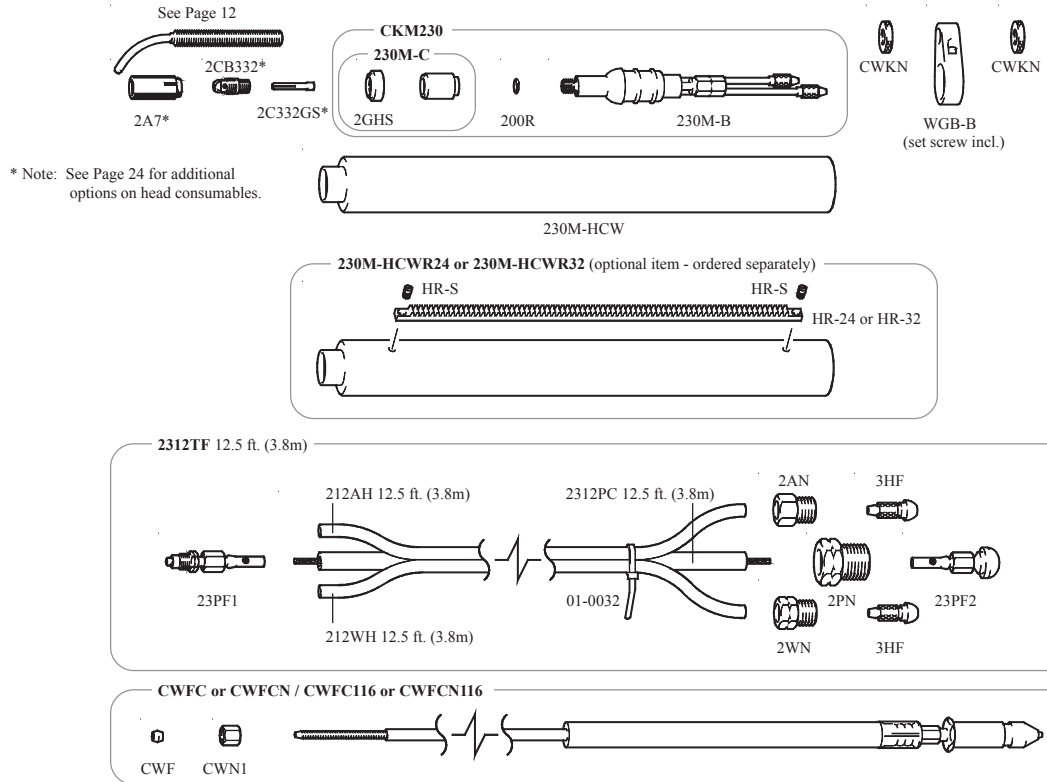

PARTSLIST:

CWM3512 MACHINE TORCH:

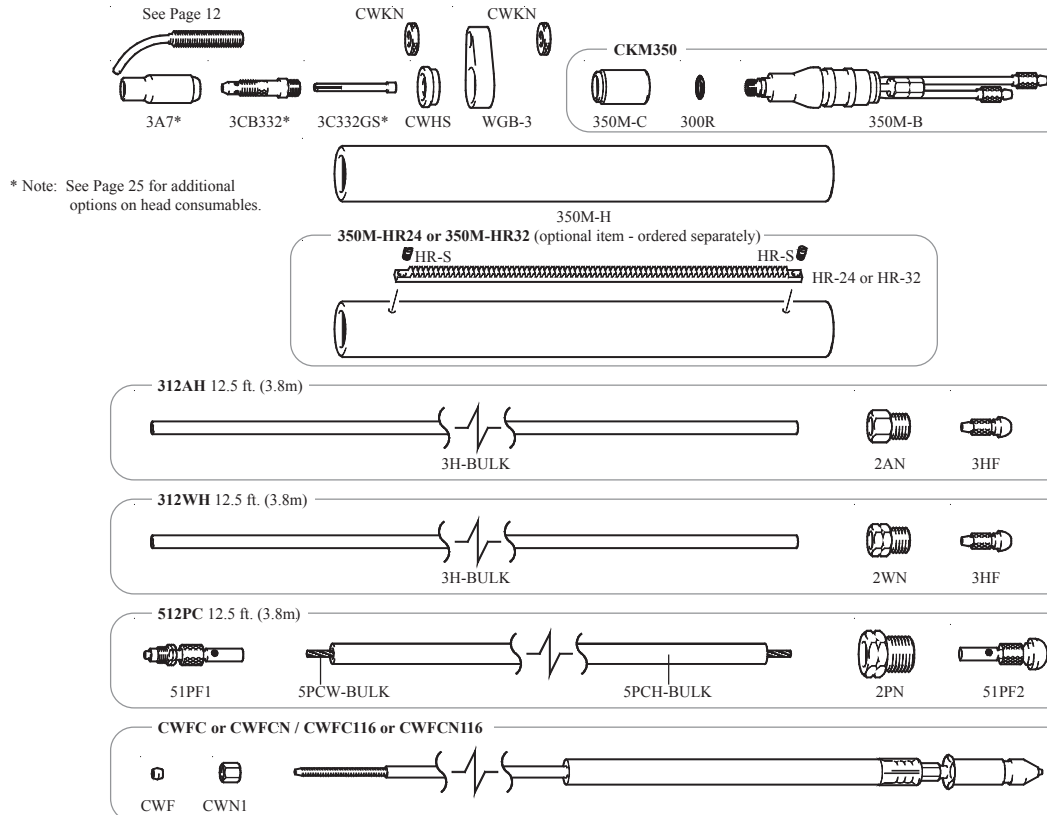



PARTSLIST:

CWMT412 MACHINE TORCH:

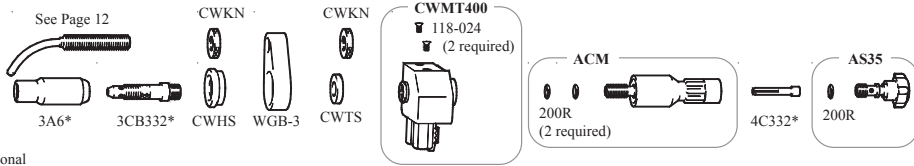

* Note: See Page 26 for additional options on head consumables.

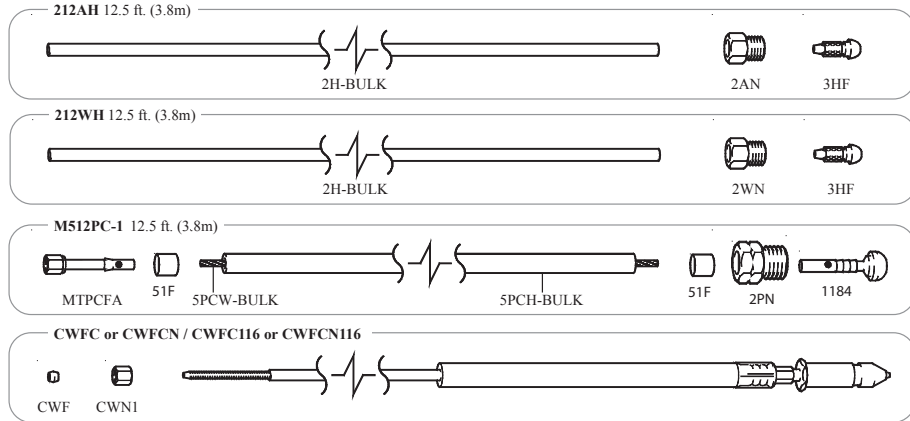

PARTSLIST:

CWMT512 MACHINE TORCH:

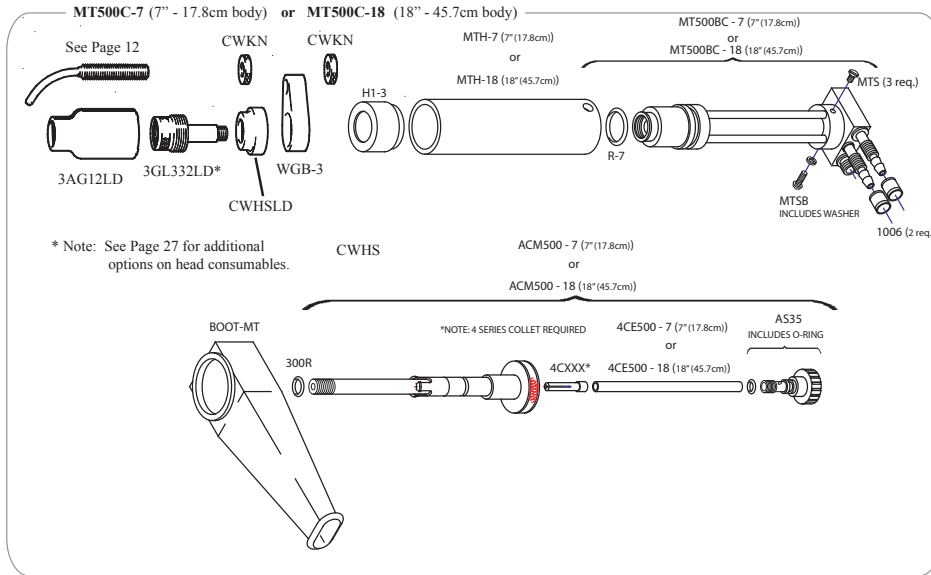

* Note: See Page 27 for additional options on head consumables.

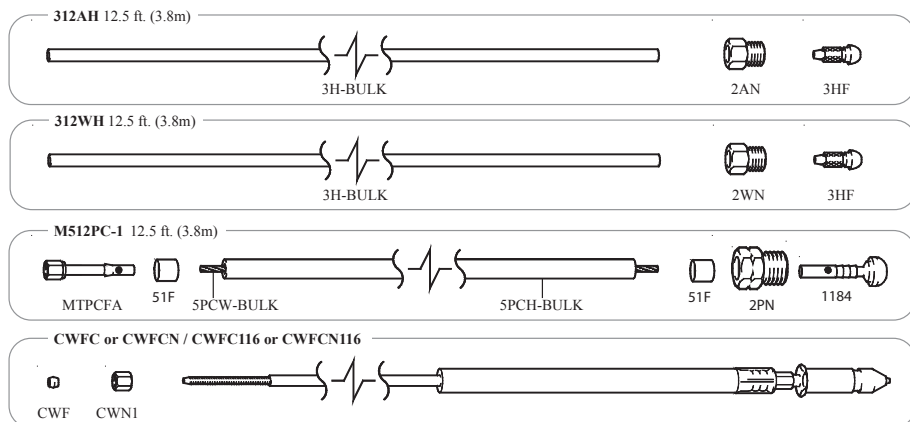



PARTS LIST:

CWH WIRE FEED HAND UNIT:

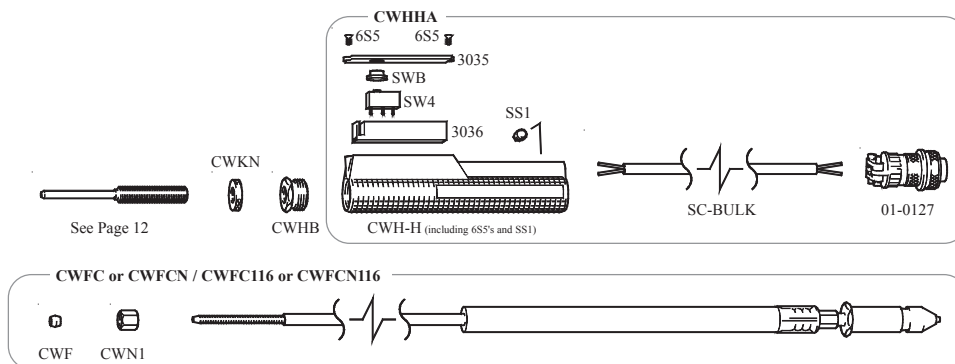

PARTS LIST:

CWMES REMOTE SWITCH:

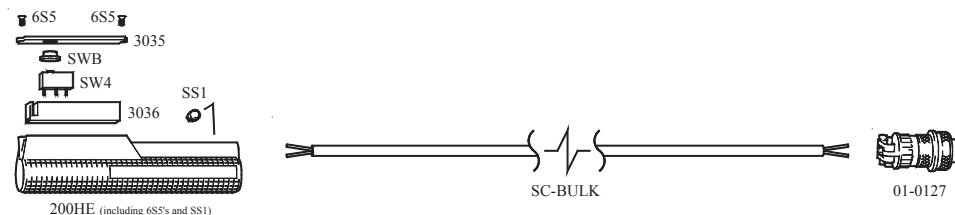

DRIVE ROLLS:

DRIVE ROLL SELECTOR CHARTS:

PART NUMBER	SIDES INCLUDED
30-45DR	B and C
45-564DR	C and D

SIDE	WIRE SIZES
B	.030" - .035" (.76mm - .89mm)
C	.045" - .047 (1.1mm - 1.2mm)
D	1/16" - 5/64" (1.6mm - 1.9mm)

SPARE PARTS:

RECOMMENDED SPARE PARTS LIST: (recommended qty.)

- Feed cables (1) See page 12
- Wire guides (2) See page 12
- Adjusting nuts (2) See torch parts list
- Heat shields (1) See torch parts list
- Cups (10) See head accessories
- Collets (10) See head accessories
- Collet bodies (6) See head accessories
- Backcaps (2) See head accessories
- Wire guide bracket extensions (1*) See page 12

*If bracket is used in application



HEAD ACCESSORIES:

8 SERIES: (CWH1812)

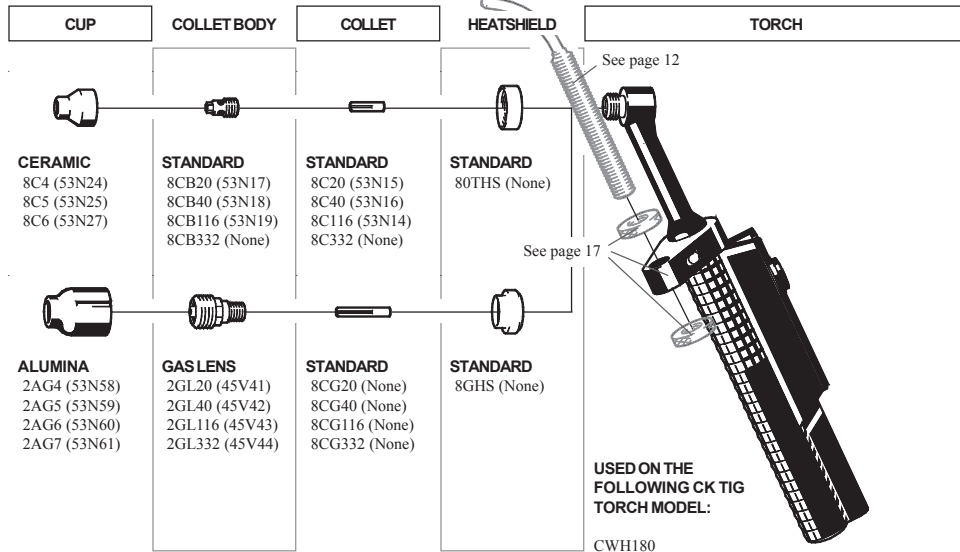

HEAD ACCESSORIES:

2 SERIES: (CWH2312)

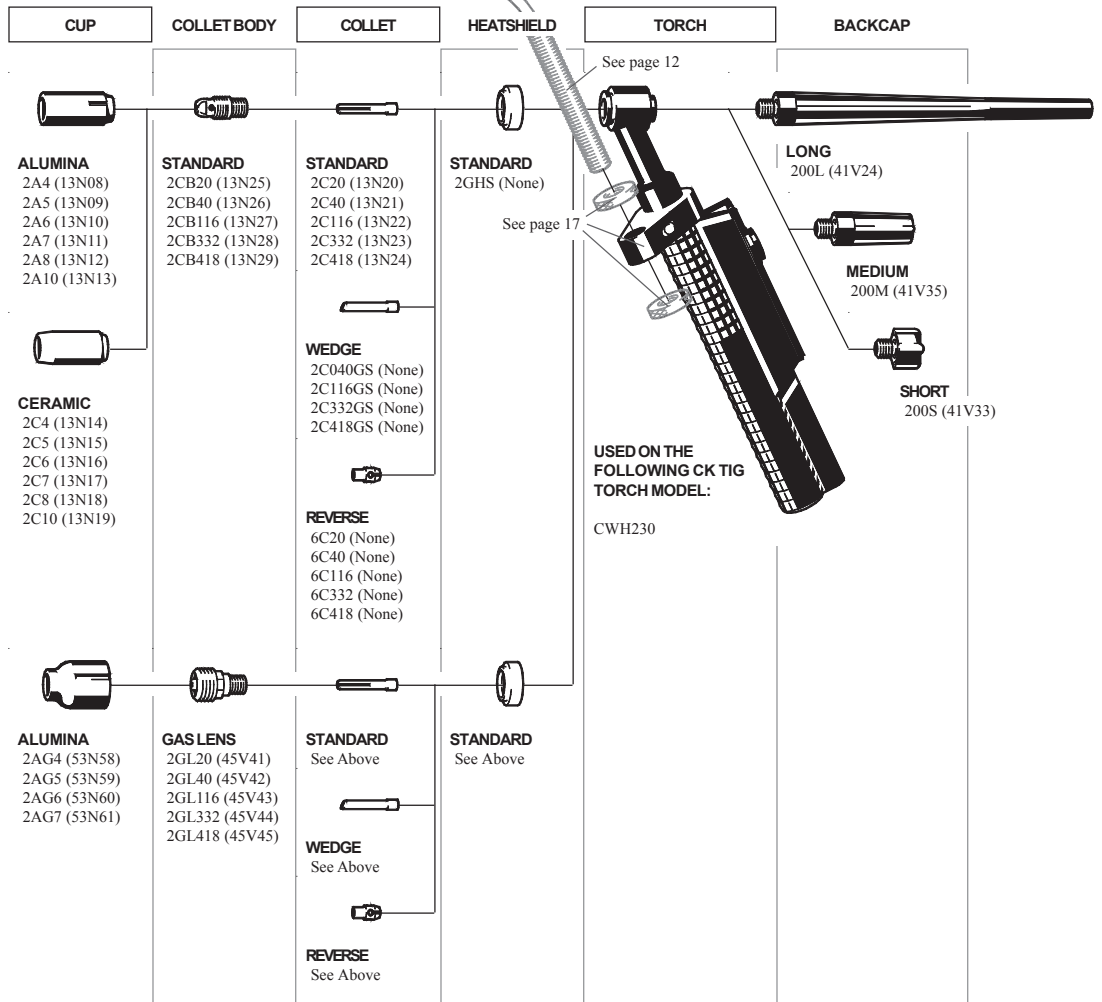



HEAD ACCESSORIES:

3 SERIES: (CWHTL312 and CWH3512)

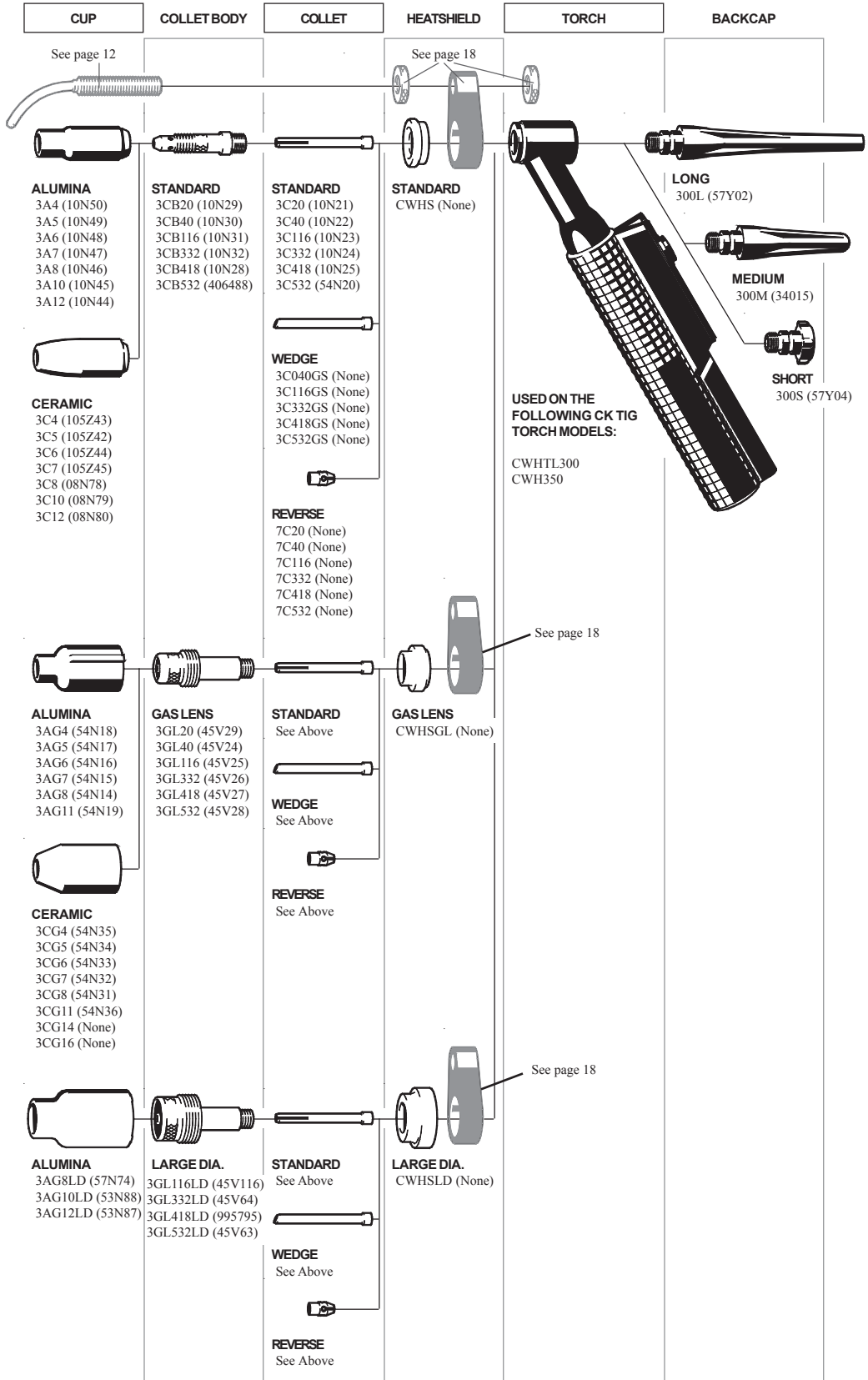



**HEAD
ACCESSORIES:**

2 SERIES: (CWM2312)

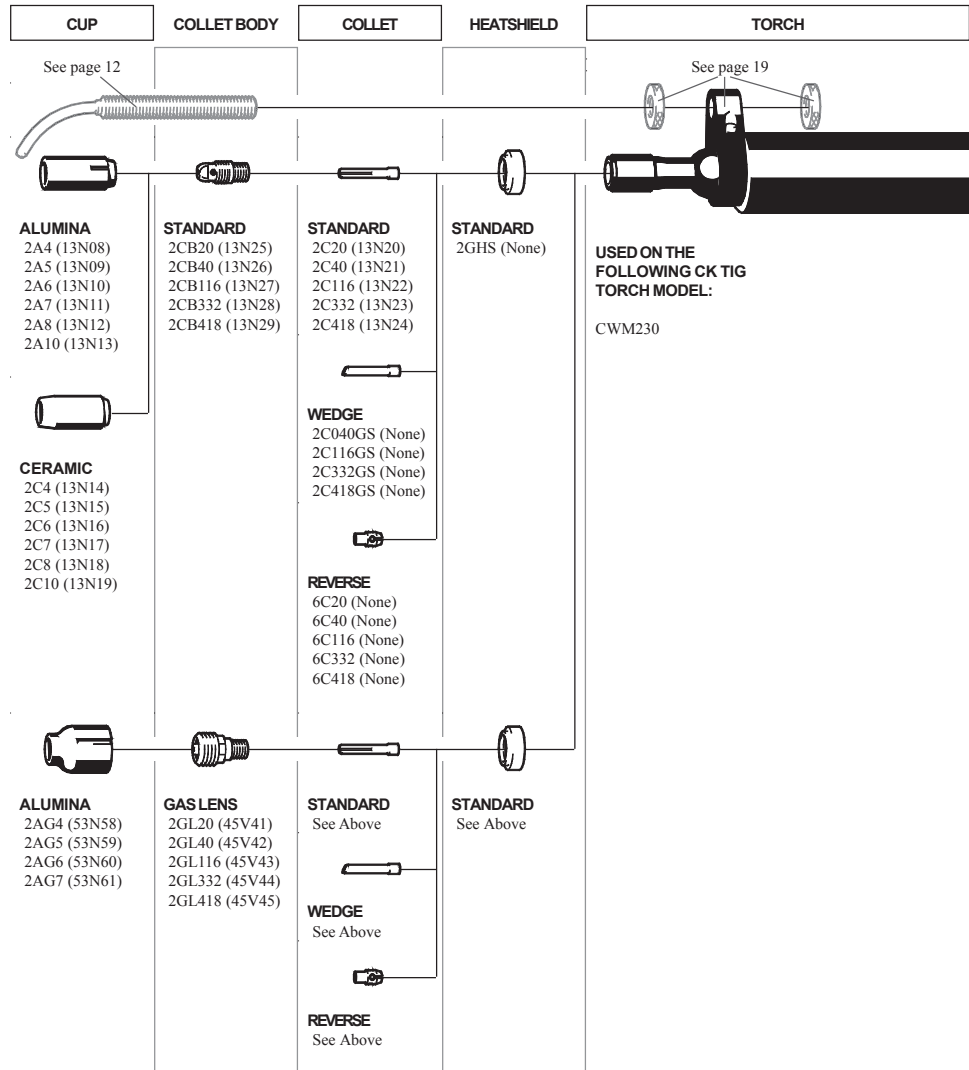



**HEAD
ACCESSORIES:**

3 SERIES: (CWM3512)

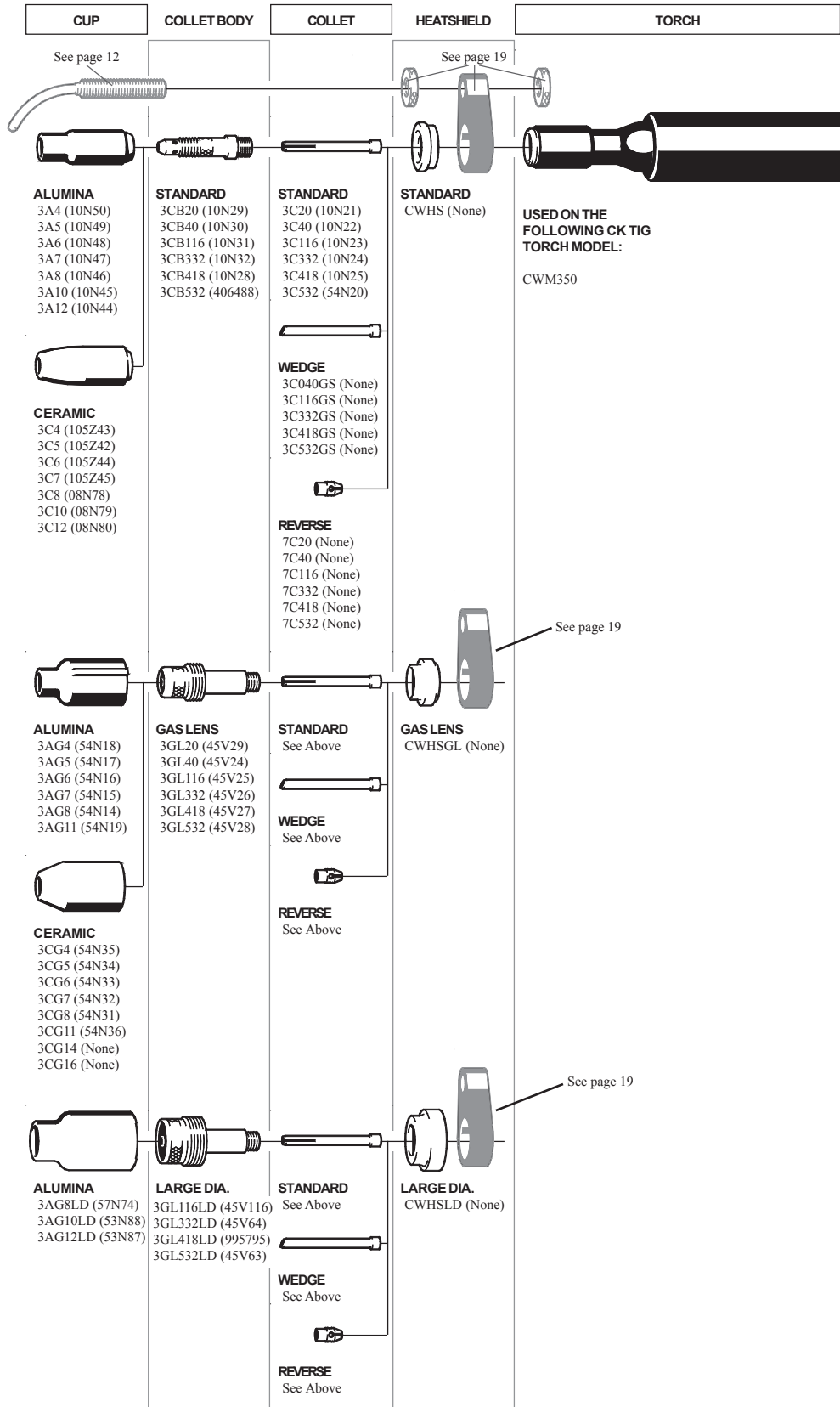

**HEAD
ACCESSORIES:**

3 SERIES: (CWMT412)

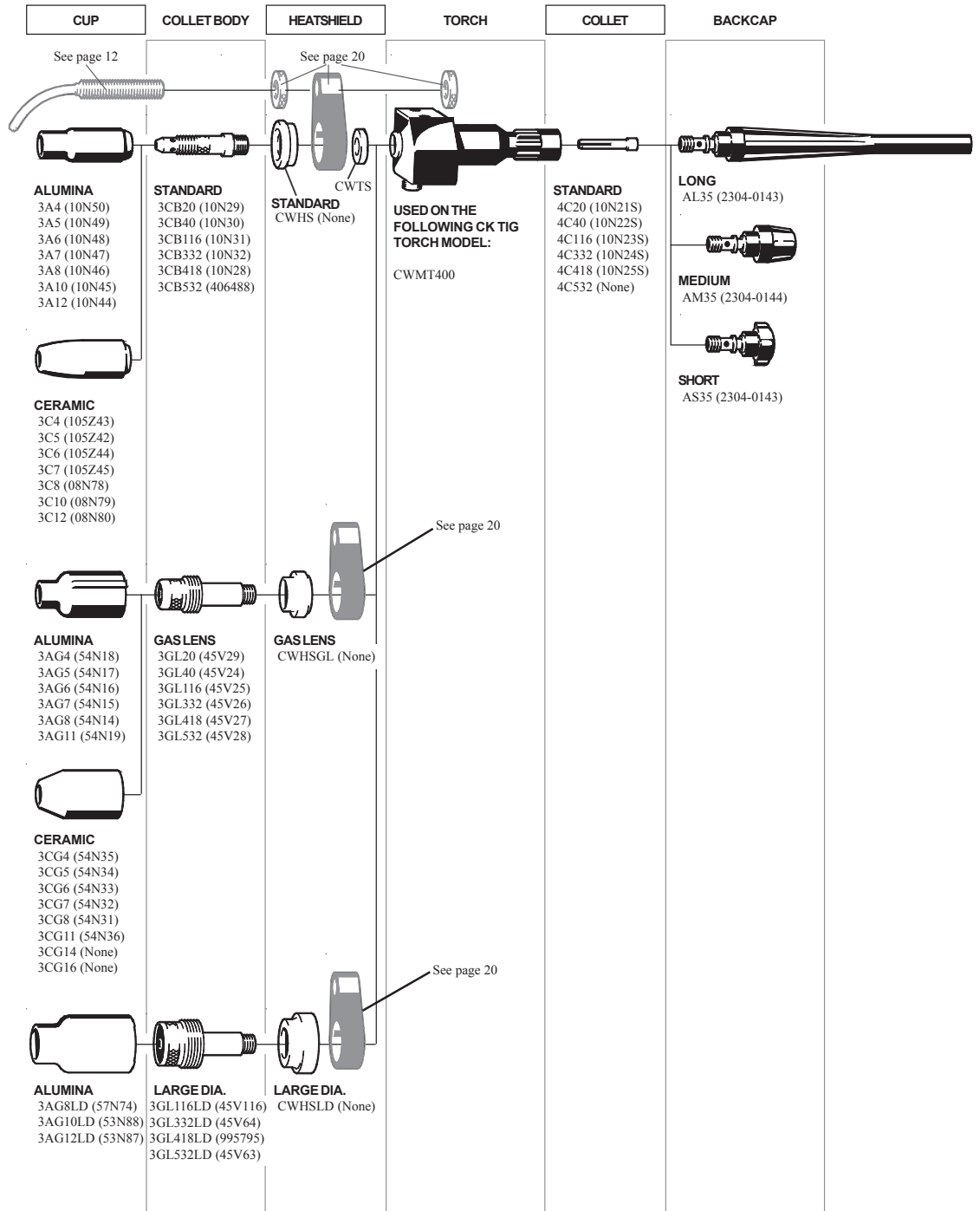

**HEAD
ACCESSORIES:**

3 SERIES: (CWMT512)

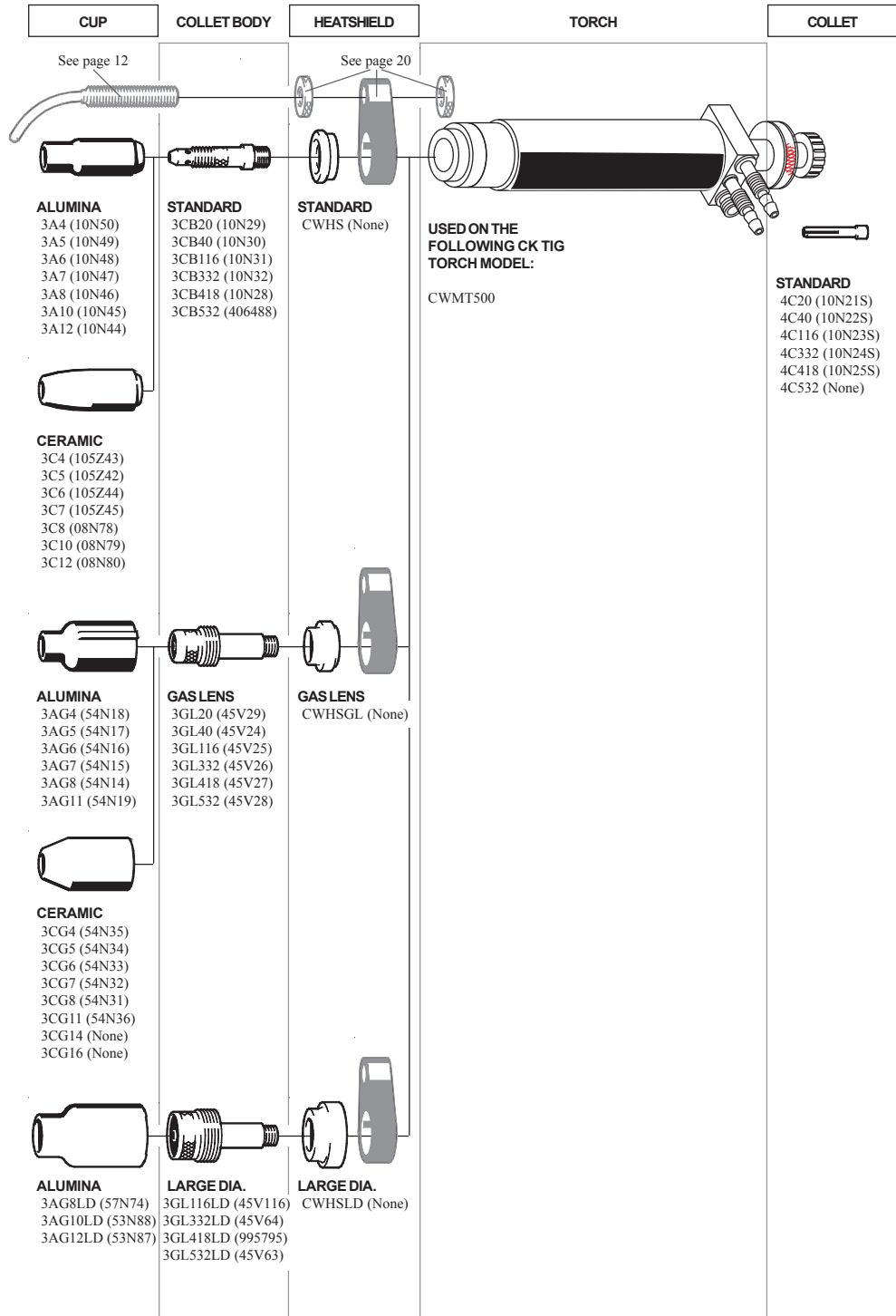



TUNGSTEN ELECTRODE CHARACTERISTICS

TUNGSTEN	COLOR CODE	CHARACTERISTICS
Pure	Green	Provides good arc stability for AC welding. Reasonably good resistance to contamination. Lowest current carrying capacity. Least expensive. Maintains a balled end. Used on transformer based machines only
2% Ceriated	Gray	Similar performance to Thoriated tungsten. Easy arc starting, good arc stability, long life. Possible replacement for Thoriated.
2% Thoriated	Red	Easier arc starting. Higher current capacity. Greater arc stability. High resistance to weld pool contamination. Difficult to maintain balled end on AC.
1.5% Lanthanated	Gold	Similar performance to Thoriated tungsten. Easy arc starting, good arc stability, long life, high current capacity. 1.5% possible replacement for Thoriated. 2% possible replacement for Pure.
2% Lanthanated	Blue	
.8% Zirconiated	White	Excellent for AC welding due to favorable retention of balled end, high resistance to contamination, and good arc starting. Preferred when tungsten contamination of weld is intolerable. Possible replacement for Pure.
LaYZr™	Chartruese*	Best for use on automated or robotic applications. Runs cooler than 2% Thoriated with longer life. Low to medium amperage range.

*Substitute for Purple (same oxide blend).

TECHNICAL INFORMATION CHART

ELECTRODE DIAMETER	CUP SIZE	WELDING CURRENT (AMPS) TUNGSTEN TYPE				ARGON FLOW FERROUS METALS		ARGON FLOW ALUMINUM	
		AC Pure	AC Thoriated	DCSP Pure	DCSP Thoriated	Standard Body CFH (L/MN)	Gas Lens Body CFH (L/MN)	Standard Body CFH (L/MN)	Gas Lens Body CFH (L/MN)
.020" (0.5mm)	3, 4, or 5	5-15	5-20	5-15	5-20	5-8 (3-4)	5-8 (3-4)	5-8 (3-4)	5-8 (3-4)
.040" (1.0mm)	4 or 5	10-60	15-80	15-20	20-80	5-10 (3-5)	5-8 (3-4)	5-12 (3-6)	5-10 (3-5)
1/16" (1.6mm)	4, 5, or 6	50-100	70-150	70-130	80-150	7-12 (4-6)	5-10 (3-5)	8-15 (4-7)	7-12 (4-6)
3/32" (2.4mm)	6, 7, or 8	100-160	140-235	150-220	150-250	10-15 (5-7)	8-10 (4-5)	10-20 (5-10)	10-15 (5-7)
1/8" (3.2mm)	7, 8, or 10	150-210	220-325	220-330	240-350	10-18 (5-9)	8-12 (4-6)	12-25 (6-12)	10-20 (5-10)
5/32" (4.0mm)	8 or 10	200-275	300-425	375-475	400-500	15-25 (7-12)	10-15 (5-7)	15-30 (7-14)	12-25 (6-12)
3/16" (4.8mm)	8 or 10	250-350	400-525	475-800	475-800	20-35 (10-17)	12-25 (6-12)	25-40 (12-19)	15-30 (7-14)
1/4" (6.4mm)	10	325-700	500-700	750-1000	700-1000	25-50 (12-24)	20-35 (10-17)	30-55 (14-26)	25-45 (12-21)

For pure helium shielding gas, double flow rates shown. For argon-helium mixes with below 30% helium content, use figures shown. Always adjust gas flows to accommodate best shielding results.

TUNGSTEN TIP PREPERATION

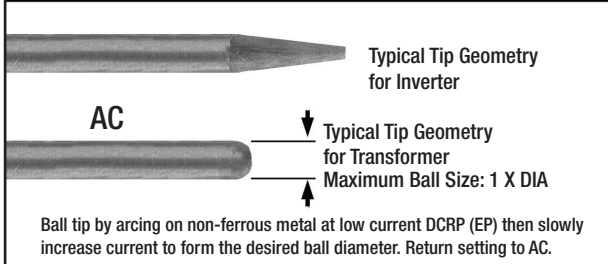
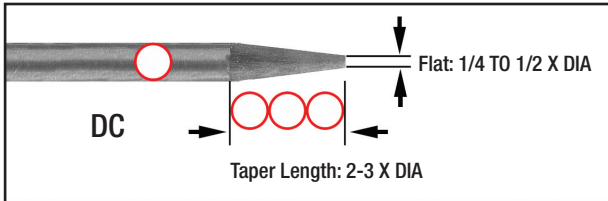

TUNGSTEN EXTENSION

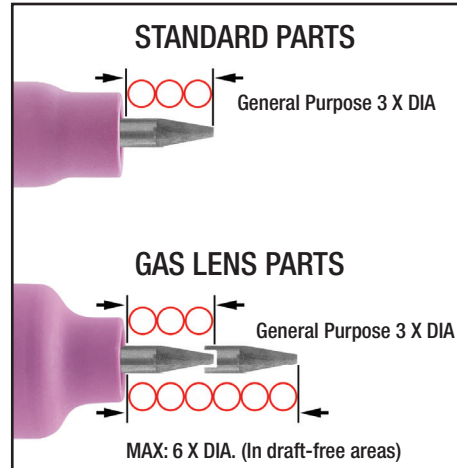

TUNGSTEN GRINDING

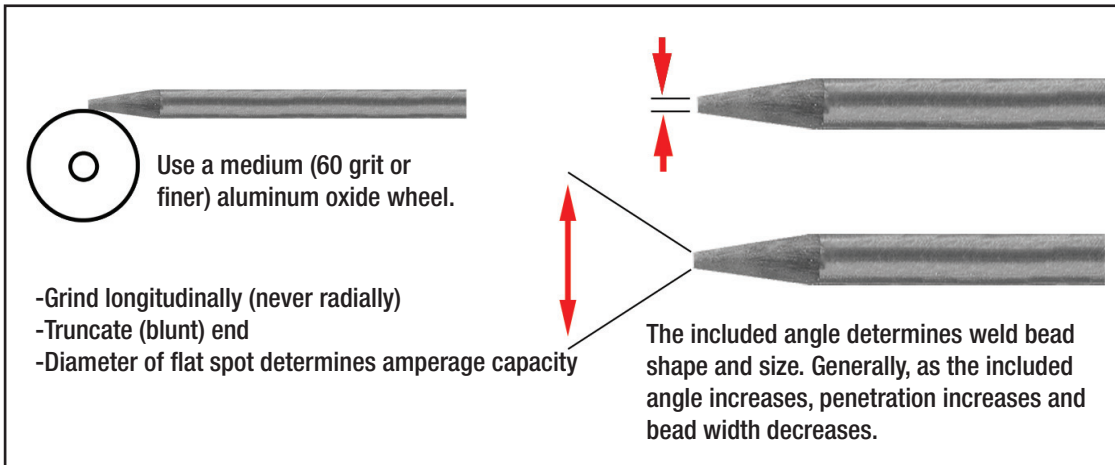

CORRECT TORCH AND ROD POSITIONING

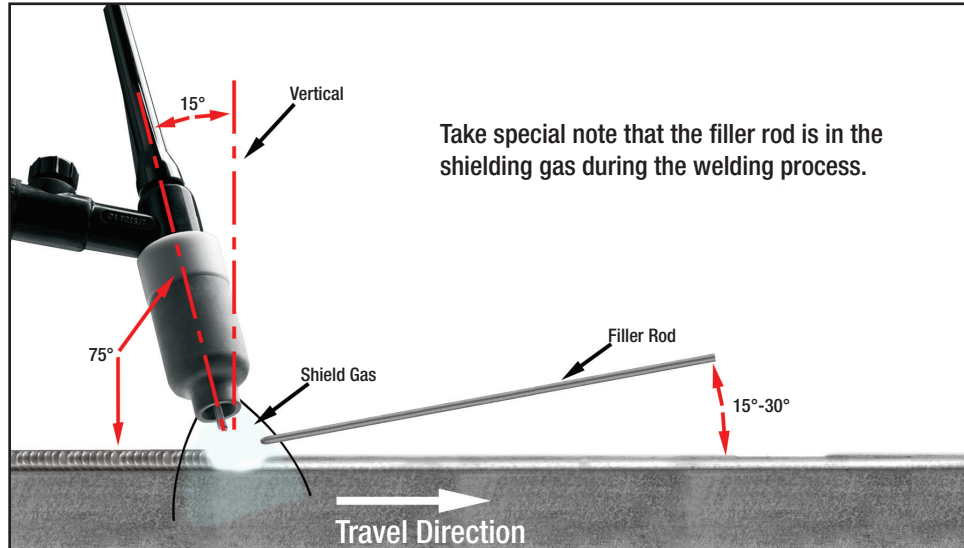



ALUMINUM

METAL GAUGE	JOINT TYPE	TUNGSTEN SIZE	FILLER ROD SIZE	CUP SIZE	SHIELD GAS FLOW			WELDING AMPERES	TRAVEL SPEED
					TYPE	CFH (L/MN)	PSI		
1/16 (1.6mm)	BUTT	1/16 (1.6mm)	1/16 (1.6mm)	4, 5, 6	ARGON	15 (7)	20	60-80	12 (307.2mm)
	FILLET							70-90	10 (256mm)
1/8 (3.2mm)	BUTT	3/32 (2.4mm)	3/32 (2.4mm)	6, 7	ARGON	17 (8)	20	125-145	12 (307.2mm)
	FILLET		1/8 (3.2mm)					140-160	10 (256mm)
3/16 (4.8mm)	BUTT	1/8 (3.2mm)	1/8 (3.2mm)	7, 8	ARGON/ HELIUM	21 (10)	20	195-220	11 (258.6mm)
	FILLET							210-240	9 (230.4mm)
1/4 (6.4mm)	BUTT	3/16 (4.8mm)	1/8 (3.2mm)	8, 10	ARGON/ HELIUM	25 (12)	20	260-300	10 (256mm)
	FILLET							280-320	8 (204.8mm)

WELDING ALUMINUM

The use of TIG welding for aluminum has many advantages for both manual and automatic processes. Filler metal can be either wire or rod and should be compatible with the base alloy. Filler metal must be dry, free of oxides, grease, or other foreign matter. If filler metal becomes damp, heat for 2 hours at 250°F (121°C) before using. Although ACHF is recommended, DCRP has been successful up to 3/32" (2.4mm), DCSP with helium shield gas is successful in mechanized applications.

TITANIUM

METAL GAUGE	JOINT TYPE	TUNGSTEN SIZE	FILLER ROD SIZE	CUP SIZE	SHIELD GAS FLOW			WELDING AMPERES	TRAVEL SPEED
					TYPE	CFH (L/MN)	PSI		
1/16 (1.6mm)	BUTT	1/16 (1.6mm)	NONE	4, 5, 6	ARGON	15 (7)	20	90-110	10 (256mm)
	FILLET							110-150	8 (204.8mm)
1/8 (3.2mm)	BUTT	3/32 (2.4mm)	1/16 (1.6mm)	5, 6, 7	ARGON	15 (7)	20	190-220	9 (230.4mm)
	FILLET							210-250	7 (179.2mm)
3/16 (4.8mm)	BUTT	3/32 (2.4mm)	1/8 (3.2mm)	6, 7, 8	ARGON	20 (10)	20	220-250	8 (204.8mm)
	FILLET							240-280	7 (179.2mm)
1/4 (6.4mm)	BUTT	1/8 (3.2mm)	1/8 (3.2mm)	8, 10	ARGON	30 (15)	20	275-310	8 (204.8mm)
	FILLET							290-340	7 (179.2mm)

WELDING TITANIUM

Small amounts of impurities, particularly oxygen and nitrogen, cause embrittlement of molten or hot titanium when above 500°F (260°C). The molten weld metal in the heat-affected zones must be shielded by a protective blanket of inert gas. Titanium requires a strong, positive pressure of argon or helium as a backup on the root side of the weld, as well as long, trailing, protective tail of argon gas to protect the metal while cooling. Purge chambers and trailing shields are available from CK Worldwide to assist in providing quality results.

MAGNESIUM

METAL GAUGE	JOINT TYPE	TUNGSTEN SIZE	FILLER ROD SIZE	CUP SIZE	SHIELD GAS FLOW			WELDING AMPERES	TRAVEL SPEED
					TYPE	CFH (L/MN)	PSI		
1/16 (1.6mm)	BUTT	1/16 (1.6mm)	3/32 (2.4mm)	5, 6	ARGON	13 (5)	15	60	20 (512mm)
	FILLET		1/8 (3.2mm)					60	
1/8 (3.2mm)	BUTT	3/32 (2.4mm)	1/8 (3.2mm)	7, 8	ARGON	19 (9)	15	115	17 (435.2mm)
	FILLET		5/32 (4.0mm)					115	
1/4 (6.4mm)	BUTT	3/16 (4.8mm)	5/32 (4.0mm)	8	ARGON	25 (12)	15	100-130	22 (563.2mm)
	FILLET							110-135	20 (512mm)
1/2 (12.8mm)	BUTT	1/4 (6.4mm)	3/16 (4.8mm)	10	ARGON	35 (17)	15	260	10 (256mm)
FILLET									

WELDING MAGNESIUM

Magnesium was one of the first metals to be welded commercially by TIG. Magnesium alloys are in three groups, they are: (1) aluminum-zinc-magnesium, (2) aluminum-magnesium, and (3) manganese-magnesium. Since magnesium absorbs a number of harmful ingredients and oxidize rapidly when subjected to welding heat, TIG welding in an inert gas atmosphere is distinctly advantageous. The welding of magnesium is similar, in many respects, to the welding of aluminum. Magnesium requires a positive pressure of argon as a backup on the root side of the weld.



DEOXIDISED COPPER

METAL GAUGE	JOINT TYPE	TUNGSTEN SIZE	FILLER ROD SIZE	CUP SIZE	SHIELD GAS FLOW			WELDING AMPERES	TRAVEL SPEED
					TYPE	CFH (L/MN)	PSI		
1/16 (1.6mm)	BUTT	1/16 (1.6mm)	1/16 (1.6mm)	4, 5, 6	ARGON	18 (9)	15	110-140	12 (307.2mm)
	FILLET							130-150	10 (256mm)
1/8 (3.2mm)	BUTT	3/32 (2.4mm)	3/32 (2.4mm)	4, 5, 6	ARGON	18 (9)	15	175-225	11 (258.6mm)
	FILLET							200-250	9 (230.4mm)
3/16 (4.8mm)	BUTT	1/8 (3.2mm)	1/8 (3.2mm)	8, 10	HELIUM	36 (17.5)	15	190-225	10 (256mm)
	FILLET							205-250	8 (204.8mm)
1/4 (6.4mm)	BUTT (2)	3/16 (4.8mm)	1/8 (3.2mm)	8, 10	HELIUM	36 (17.5)	15	225-260	9 (230.4mm)
	FILLET							250-280	7 (179.2mm)

WELDING DEOXIDIZED COPPER

Where extensive welding is to be done, the use of deoxidized (oxygen-free) copper is preferable over electrolytic tough pitch copper. Although TIG welding has been used occasionally to weld zinc-bearing copper alloys, such as brass and commercial bronzes, it is not recommended because the shielding gas does not suppress the vaporization of zinc. For the same reason zinc bearing filler rods should not be used. There is some preference of helium for the inert atmosphere in welding thickness above 1/8" (3.2mm) because of the improved weld metal fluidity. Preheating recommendations should be followed.

STAINLESS STEEL

METAL GAUGE	JOINT TYPE	TUNGSTEN SIZE	FILLER ROD SIZE	CUP SIZE	SHIELD GAS FLOW			WELDING AMPERES	TRAVEL SPEED
					TYPE	CFH (L/MN)	PSI		
1/16 (1.6mm)	BUTT	1/16 (1.6mm)	1/16 (1.6mm)	4, 5, 6	ARGON	11 (5.5)	20	80-100	12 (307.2mm)
	FILLET							90-100	10 (256mm)
1/8 (3.2mm)	BUTT	1/16 (1.6mm)	3/32 (2.4mm)	4, 5, 6	ARGON	11 (5.5)	20	120-140	12 (307.2mm)
	FILLET							130-150	10 (256mm)
3/16 (4.8mm)	BUTT	3/32 (2.4mm)	1/8 (3.2mm)	5, 6, 7	ARGON	13 (6)	20	200-250	12 (307.2mm)
	FILLET	3/32 (2.4mm) 1/8 (3.2mm)						225-275	10 (256mm)
1/4 (6.4mm)	BUTT	1/8 (3.2mm)	3/16 (4.8mm)	8, 10	ARGON	13 (6)	20	275-350	10 (256mm)
	FILLET							300-375	8 (204.8mm)

WELDING STAINLESS STEEL

In TIG welding of stainless steel, welding rods having the AWS-ASTM prefixes of E or ER can be used as filler rods. However, only bare uncoated rods should be used. Light gauge metals less than 1/16" (1.6mm) thick should always be welded with DCSP using argon gas. Follow the normal precautions for welding stainless such as: Clean surfaces; dry electrodes; use only stainless steel tools and brushes, keep stainless from coming in contact with other metals.

LOW ALLOY STEEL

METAL GAUGE	JOINT TYPE	TUNGSTEN SIZE	FILLER ROD SIZE	CUP SIZE	SHIELD GAS FLOW			WELDING AMPERES	TRAVEL SPEED
					TYPE	CFH (L/MN)	PSI		
1/16 (1.6mm)	BUTT	1/16 (1.6mm)	1/16 (1.6mm)	4, 5, 6	ARGON	15 (7)	20	95-135	15 (384mm)
	FILLET							95-135	15 (384mm)
1/8 (3.2mm)	BUTT	1/16 (1.6mm)	3/32 (2.4mm)	4, 5, 6	ARGON	15 (7)	20	145-205	11 (258.6mm)
	FILLET	3/32 (2.4mm)						145-205	11 (258.6mm)
3/16 (4.8mm)	BUTT	3/32 (2.4mm)	1/8 (3.2mm)	7, 8	ARGON	16 (6.5)	20	210-260	10 (256mm)
	FILLET							210-260	10 (256mm)
1/4 (6.4mm)	BUTT	1/8 (3.2mm)	5/32 (4.0mm)	8, 10	ARGON	18 (8.5)	20	240-300	10 (256mm)
	FILLET (2)							240-300	10 (256mm)

WELDING LOW ALLOY STEEL

Mild and low carbon steels with less than 0.30% carbon and less than 1" (2.5cm) thick, generally do not require preheat. An exception to this allowance is welding on highly restrained joints. These joints should be preheated 50 to 100°F (10 to 38°C) to minimize shrinkage cracks in the base metal. Low alloy steels such as the chromium-molybdenum steels will have hard heat affected zones after welding, if the preheat temperature is too low. This is caused by rapid cooling of the base material and the formation of martensitic grain structures. A 200 to 400°F (93 to 204°C) preheat temperature will slow the cooling rate and prevent the martensitic structure.



CK Worldwide, Inc.
3501 C St. N.E. Auburn, WA 98002
Phone: (800) 426-0877
Fax: (800) 327-5038
www.CKWORLDWIDE.com
Form 5701